



Engineering Guide

Copyright 1986 by Eclipse, Inc.
1665 Elmwood Rd.
Rockford, IL 61103

EFE 825, 8/02
Electronic Edition
Published by
Eclipse, Inc.
All Rights Reserved

**OPEN
GUIDE**

**OPEN
TECH NOTES**



CONTENTS

1. Orifices & Flows

Coefficients of Discharge for Various Types of Orifices	4
Orifice Flow Formulas	4
Orifice Capacity Tables, Low Pressure Gas	5
Orifice Capacity Tables, High Pressure Gas	9
Piping Pressure Losses, Air	12
Piping Pressure Losses, Natural Gas	13
High Pressure (Compressible) Flow of Natural Gas in Pipes	14
Equivalent Lengths of Standard Pipe Fittings & Valves	14
Simplified Selection of Air, Gas and Mixture Piping Size	15
Quick Method for Sizing Air Piping	15
Sizing Branch Piping by the Equal Area Method	16
C _v Flow Factor Conversion	16
Duct Velocity & Flow Measurement	17

2. Fan Laws & Blower Application Engineering

Theoretical Flow	18
Fan Laws	19
Blower Horsepower Requirements	20
Blowers Used as Suction Fans	20
The Effect of Pressure on Air	20
The Effect of Altitude on Air	20
The Effect of Temperature on Air	21

3. Gas

Physical Properties of Commercial Fuel Gases	22
Combustion Properties of Commercial Fuel Gases	
Air/Gas Ratio, Flammability Limits, Ignition Temperature & Flame Velocity . . .	22
Heating Value, Heat Release & Flame Temperature	23
Combustion Products & CO ₂	23
Equivalent Propane/Air & Butane/Air Btu Tables	24
Propane/Air & Butane/Air Mixture Specifications	24

4. Oil

Fuel Oil Specifications Per ANSI/ASTM D 396-79	25
Typical Properties of Commercial Fuel Oils in the U.S.	26
Fuel Oil Viscosity Conversions	26
°API Vs. Oil Specific Gravity & Gross Heating Value	27
Oil Piping Pressure Losses	27
Oil Temperature Drop in °F Per 100 Foot of Pipe	29

5. Steam & Water

Boiler Terminology & Conversion Factors	30
Properties of Saturated Steam	30
Btu/Hr. Required to Generate One Boiler H.P.	31
Sizing Water Piping	31
Sizing Steam Piping	31

6. Electrical Data

Electrical Formulas	33
Electrical Wire – Dimensions & Ratings	33
NEMA Size Starters for Motors	33
NEMA Enclosures	34
Electric Motors – Full Load Current, Amperes	34

7. Process Heating

Heat Balances – Determining the Heat Needs of Furnaces and Ovens	35
Thermal Properties of Various Materials	37
Thermal Capacities of Metals & Alloys	40
Industrial Heating Operations – Temperature & Heat Requirements	41
Crucibles for Metal Melting – Dimensions & Capacities	43
Radiant Tubes – Sizing & Input Data	43
Heat Losses, Heat Storage & Cold Face Temperatures – Refractory Walls	44
Air Heating & Fume Incineration Heat Requirements	
Using “Raw Gas” Burners	45
Using Burners with Separate Combustion Air Sources	45
Fume Incineration – Selection & Sizing Guidelines	46
Liquid Heating – Burner Sizing Guidelines	47
Black Body Radiation	49
Thermocouple Data	49
Orton Standard Pyrometric Cone Temperature Equivalents	50

8. Combustion Data

Available Heat for Birmingham Natural Gas	51
Available Heat for Various Fuel Gases	51
Flue Gas Analysis Chart	52
Theoretical Flame Tip Temperature vs. Excess Air	52
Heat Transfer Relationships	52
Thermal Head & Cold Air Infiltration into Furnaces	53
Furnace Flue Sizing	53

9. Mechanical Data

Dimensional and Capacity Data – Schedule 40 Pipe	54
Dimensions of Malleable Iron Threaded Fittings	55
Sheet Metal Gauges & Weights	56
Steel Wire Gauges & Weights	56
Circumferences & Areas of Circles	57
Drill Size Data	59
Tap Drill Sizes	60
Drilling Templates – Pipe Flanges	60

10. Abbreviations & Symbols

Abbreviations	61
Electrical Symbols	62

11. Conversion Factors

General Conversion Factors	64
Temperature Conversions	68
Pressure Conversions	69
Index	72

Tech Notes

Table of Contents	73
-------------------	----

CHAPTER 1 – ORIFICES & FLOWS

COEFFICIENTS OF DISCHARGE FOR VARIOUS TYPES OF ORIFICES

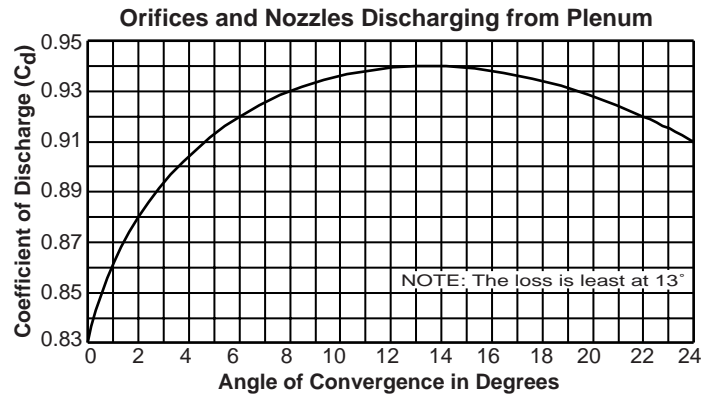
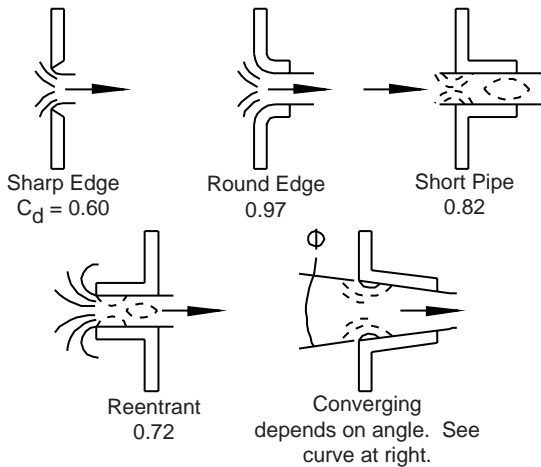

ORIFICE FLOW FORMULAS

The flow of air or gas through an orifice can be determined by the formula

$$Q = 1658.5 \times A \times C_d \sqrt{\frac{h}{g}}$$

where Q = flow, cfh

A = area of the orifice, sq. in. (see Pages 57 & 58)

C_d = discharge coefficient of the orifice (see above)

h = pressure drop across the orifice, " w.c.

g = specific gravity of the gas, based on standard air at 1.0 (see Pages 19, 20, & 22 thru 24.)

1. Sizing Orifice Plates

To calculate the size of an orifice plate, this equation can be rearranged as follows:

$$A = \frac{Q}{1658.5 \times C_d} \times \sqrt{\frac{g}{h}}$$

2. Effect of Changes in Operating Conditions on Flow through an Orifice – General Relationship

$$\frac{Q_2}{Q_1} = \frac{A_2}{A_1} \times \frac{C_{d2}}{C_{d1}} \times \sqrt{\frac{h_2}{h_1}} \times \sqrt{\frac{g_1}{g_2}}$$

If any of the factors in this relationship remain constant from Condition 1 to Condition 2, they can be dropped out of the equation, yielding these simplified relationships. Each of them assumes only one factor has been changed.

2a. Flow Change vs. Orifice Area Change

$$\frac{Q_2}{Q_1} = \frac{A_2}{A_1}$$

2b. Flow Change vs. Pressure Drop Change

$$\frac{Q_2}{Q_1} = \sqrt{\frac{h_2}{h_1}}$$

This is the so-called "square root law."

2c. Flow Change vs. Specific Gravity Change

$$\frac{Q_2}{Q_1} = \sqrt{\frac{g_1}{g_2}}$$

3. Effect of Changes in Operating Conditions on Pressure Drop Across an Orifice—General Relationship:

$$\frac{h_2}{h_1} = \left(\frac{Q_2}{Q_1}\right)^2 \times \left(\frac{A_1}{A_2}\right)^2 \times \left(\frac{C_{d1}}{C_{d2}}\right)^2 \times \frac{g_2}{g_1}$$

Again, if any of the factors in this equation are unchanged from Condition 1 to Condition 2, they can be dropped out to form simplified relationships:

3a. Pressure Drop Change vs. Flow Change

$$\frac{h_2}{h_1} = \left(\frac{Q_2}{Q_1}\right)^2$$

This is the square root law, stated another way.

3b. Pressure Drop Change vs. Orifice Area Change

$$\frac{h_2}{h_1} = \left(\frac{A_1}{A_2}\right)^2$$

3c. Pressure Drop Change vs. Specific Gravity Change

$$\frac{h_2}{h_1} = \frac{g_2}{g_1}$$

This relationship may not apply where specific gravity has been changed by a change in gas temperature. See Page 25.

4. Effect of Changes in Gas Temperature on Flow and Pressure Drop through an Orifice

Raising a gas's temperature has two effects – it increases the volume and decreases the specific gravity, both in proportion to the ratio of the absolute temperatures. If we are concerned with changes in mass flows (scfh), these relationships must be used:

4a. Flow Change vs. Temperature Change

$$\frac{Q_2}{Q_1} = \sqrt{\frac{T_{ABS1}}{T_{ABS2}}}$$

4b. Pressure Drop Change vs. Temperature Change

$$\frac{h_2}{h_1} = \frac{T_{ABS2}}{T_{ABS1}} \text{ to maintain constant scfh}$$

ORIFICE CAPACITY TABLES LOW PRESSURE GAS

Flows in these tables are based on an orifice pressure drop of 1" w.c. and a coefficient of discharge (C_d) of 1.0.

To determine flow through an orifice of a known diameter:

1. Locate the orifice diameter in the left-hand column of the table.
2. Read across to the column corresponding to the gas being measured. This is the uncorrected flow.
3. Multiply this flow by the coefficient of discharge of the orifice. (see page 4)
4. Correct this flow to the pressure drop actually measured, using the square root law (equation 2b, page 4).

Example: What is the flow of natural gas through a 7/32" diameter sharp edge orifice at 6" w.c. pressure drop?

From the table, uncorrected natural gas flow through a 7/32" orifice is 80.7 cfh at 1" w.c.

C_d for a sharp edge orifice is 0.60 (page 1.1), so corrected flow is $80.7 \times 0.60 = 48.4$ cfh at 1" w.c. pressure drop.

Per equation 2b, page 4,

$$\frac{Q_2}{Q_1} = \sqrt{\frac{h_2}{h_1}} \text{ or } Q_2 = Q_1 \times \sqrt{\frac{h_2}{h_1}}$$

Substituting the numbers for this case:

$$Q_2 = 48.4 \times \sqrt{\frac{6'' \text{ w.c.}}{1'' \text{ w.c.}}} = 119 \text{ cfh}$$

To determine the orifice size to handle a known flow at a specified pressure drop, reverse the process:

1. Correct the known flow to a pressure drop of 1" w.c., using the square root law.
2. Divide the flow by the orifice coefficient.
3. In the orifice table, locate the column for the gas under consideration. In this column, locate the flow closest to the corrected value found in step 2.
4. Read to the left to find the corrected orifice size.

Example: Size a gas jet for a mixer. Entrance to the jet orifice

converges at a 15° included angle. Gas is propane. Required flow is 120 cfh at 30" w.c. pressure drop.

Per equation 2b, page 4,

$$\frac{Q_2}{Q_1} = \sqrt{\frac{h_2}{h_1}}, \text{ or } Q_2 = Q_1 \times \sqrt{\frac{h_2}{h_1}}$$

Substituting the numbers for this case:

$$Q_2 = 120 \times \sqrt{\frac{1}{30}} = 22 \text{ cfh}$$

From page 1.1, C_d for a 15° convergent nozzle is 0.94, so corrected flow is

$$22 \div 0.94 = 23.4 \text{ cfh.}$$

Locate 23.4 cfh in the propane column of the orifice table and then read to the left to find a #26 drill size orifice.

CAPACITY, CFH @ 1" W.C. PRESSURE DROP AND COEFFICIENT OF DISCHARGE OF 1.0

Drill Size	Dia. In.	Area	Natural Gas		Propane/Air		Propane	Butane
			0.60 Sp. Gr.	1.0 Sp. Gr.	1.29 Sp. Gr.	1.5 Sp. Gr.	2.0 Sp. Gr.	
80	.0135	.000143	.308	.239	.210	.195	.169	
79	.0145	.000165	.355	.275	.242	.225	.195	
1/64	.0156	.00019	.409	.317	.279	.259	.224	
78	.016	.00020	.431	.334	.294	.272	.236	
77	.018	.00025	.538	.417	.367	.340	.295	
76	.020	.00031	.668	.517	.455	.422	.366	
75	.021	.00035	.754	.584	.514	.477	.413	
74	.0225	.00040	.861	.668	.587	.545	.472	
73	.024	.00045	.969	.751	.661	.613	.531	
72	.025	.00049	1.06	.817	.720	.667	.578	
71	.026	.00053	1.14	.884	.778	.722	.625	
70	.028	.00062	1.33	1.03	.910	.844	.731	
69	.0292	.00067	1.44	1.12	.984	.912	.790	
68	.030	.00075	1.61	1.25	1.10	1.02	.885	
1/32	.0312	.00076	1.64	1.27	1.12	1.04	.896	
67	.032	.00080	1.72	1.33	1.17	1.09	.944	
66	.033	.00086	1.85	1.43	1.26	1.17	1.01	
65	.035	.00092	2.07	1.60	1.41	1.31	1.13	
64	.036	.00102	2.20	1.70	1.50	1.39	1.20	
63	.037	.00108	2.33	1.80	1.59	1.47	1.27	
62	.038	.00113	2.43	1.88	1.66	1.54	1.33	
61	.039	.00119	2.56	1.98	1.75	1.62	1.40	
60	.040	.00126	2.71	2.10	1.85	1.72	1.49	
59	.041	.00132	2.84	2.20	1.94	1.8	1.56	
58	.042	.00138	2.97	2.30	2.03	1.88	1.63	

**CAPACITY, CFH @ 1" W.C. PRESSURE DROP
AND COEFFICIENT OF DISCHARGE OF 1.0**

Drill Size	Dia. In.	Area	Natural Gas	Air	Propane/ Air	Propane	Butane
			0.60 Sp. Gr.	1.0 Sp. Gr.	1.29 Sp. Gr.	1.5 Sp. Gr.	2.0 Sp. Gr.
57	.043	.00145	3.12	2.42	2.13	1.97	1.71
56	.0465	.00170	3.66	2.84	2.5	2.32	2.01
3/64	.0469	.00173	3.73	2.89	2.54	2.36	2.04
55	.0520	.00210	4.52	3.50	3.08	2.86	2.48
54	.0550	.0023	4.95	3.84	3.38	3.13	2.71
53	.0595	.0028	6.03	4.67	4.11	3.81	3.30
1/16	.0625	.0031	6.68	5.17	4.55	4.22	3.66
52	.0635	.0032	6.89	5.34	4.7	4.36	3.77
51	.0670	.0035	7.54	5.84	5.14	4.77	4.13
50	.070	.0038	8.18	6.34	5.58	5.18	4.48
49	.073	.0042	9.04	7.01	6.17	5.72	4.95
48	.076	.0043	9.26	7.17	6.31	5.86	5.07
5/64	.0781	.0048	10.3	8.01	7.05	6.54	5.66
47	.0785	.0049	10.5	8.17	7.2	6.67	5.78
46	.081	.0051	11.	8.51	7.49	6.95	6.02
45	.082	.0053	11.4	8.84	7.78	7.22	6.25
44	.086	.0058	12.5	9.67	8.52	7.9	6.84
43	.089	.0062	13.4	10.3	9.11	8.44	7.31
42	.0935	.00687	14.8	11.4	10.	9.36	8.1
3/32	.0937	.0069	14.9	11.5	10.1	9.40	8.14
41	.096	.0072	15.5	12.	10.6	9.81	8.49
40	.098	.0075	16.2	12.5	11.	10.2	8.85
39	.0995	.0078	16.8	13.	11.5	10.6	9.2
38	.1015	.0081	17.4	13.5	11.9	11.0	9.55
37	.104	.0085	18.3	14.2	12.5	11.6	10.
36	.1065	.0090	19.4	15.	13.2	12.3	10.6
7/64	.1093	.0094	20.2	15.7	13.8	12.8	11.1
35	.110	.0095	20.5	15.8	14.	12.9	11.2
34	.111	.0097	20.9	16.2	14.2	13.2	11.4
33	.113	.0100	21.5	16.7	14.7	13.6	11.8
32	.116	.0106	22.8	17.7	15.6	14.4	12.5
31	.120	.0113	24.3	18.8	16.6	15.4	13.3
1/8	.125	.0123	26.4	20.4	18.	16.7	14.5
30	.1285	.0130	27.9	21.6	19.	17.6	15.3
29	.136	.0145	31.1	24.1	21.2	19.7	17.
28	.1405	.0155	33.3	25.8	22.7	21.	18.2
9/64	.1406	.0156	33.5	25.9	22.8	21.2	18.3
27	.144	.0163	35.	27.1	23.9	22.1	19.2
26	.147	.0174	37.3	28.9	25.5	23.6	20.4
25	.1495	.0175	37.5	29.1	25.6	23.7	20.6
24	.152	.0181	38.8	30.1	26.5	24.6	21.3
23	.154	.0186	39.9	30.9	27.2	25.2	21.9
5/32	.1562	.0192	41.2	31.9	28.1	26.1	22.6
22	.157	.0193	41.4	32.1	28.2	26.2	22.7
21	.159	.0198	42.5	32.9	29.	26.9	23.3
20	.161	.0203	43.6	33.7	29.7	27.5	23.9
19	.166	.0216	46.3	35.9	31.6	29.3	25.4
18	.1695	.0226	48.5	37.6	33.1	30.7	26.6
11/64	.1719	.0232	49.8	38.6	33.9	31.5	27.3
17	.175	.0235	50.4	39.1	34.4	31.9	27.6
16	.177	.0246	52.8	40.9	36.	33.4	28.9
15	.180	.0254	54.5	42.2	37.2	34.5	29.9
14	.182	.0260	55.8	43.2	38.	35.3	30.6
13	.185	.0269	57.7	44.7	39.4	36.5	31.6
3/16	.1875	.0276	59.2	45.9	40.4	37.5	32.4

**CAPACITY, CFH @ 1" W.C. PRESSURE DROP
AND COEFFICIENT OF DISCHARGE OF 1.0**

Drill Size	Dia. In.	Area	Natural Gas	Air	Propane/ Air	Propane	Butane
			0.60 Sp. Gr.	1.0 Sp. Gr.	1.29 Sp. Gr.	1.5 Sp. Gr.	2.0 Sp. Gr.
12	.189	.02805	60.2	46.6	41.	38.1	33.
11	.191	.02865	61.5	47.6	41.9	38.9	33.7
10	.1935	.0294	63.1	48.9	43.	39.9	34.6
9	.196	.0302	64.8	50.2	44.2	41.	35.5
8	.199	.0311	66.7	51.7	45.5	42.2	36.5
7	.201	.0316	67.8	52.5	46.2	42.9	37.1
13/64	.2031	.0324	69.5	53.8	47.4	44.	38.1
6	.204	.0327	70.2	54.3	47.8	44.4	38.4
5	.2055	.0332	71.2	55.2	48.6	45.1	39.
4	.209	.0343	73.6	57.0	50.2	46.5	40.3
3	.213	.0356	76.4	59.2	52.1	48.3	41.8
7/32	.2187	.0376	80.7	62.5	55.	51.	44.2
2	.221	.0384	82.4	63.8	56.2	52.1	45.1
1	.228	.0409	87.8	68.	59.8	55.5	48.1
A	.234	.0430	92.3	71.5	62.9	58.4	50.5
15/64	.2343	.0431	92.5	71.6	63.1	58.5	50.7
B	.238	.0444	95.3	73.8	65.	60.3	52.2
C	.242	.0460	98.7	76.5	67.3	62.4	54.1
D	.246	.0475	102.	78.9	69.5	64.5	55.8
1/4	.250	.0491	105.	81.6	71.8	66.6	57.7
F	.257	.0519	111.	86.3	75.9	70.4	61.
G	.261	.0535	115.	88.9	78.3	72.6	62.9
17/64	.2656	.0554	119.	92.1	81.1	75.2	65.1
H	.266	.0556	119.3	92.4	81.4	75.4	65.3
I	.272	.0580	124.	96.4	84.9	78.7	68.2
J	.277	.0601	129.	99.9	87.9	81.6	70.6
K	.281	.0620	133.	103.	90.7	84.1	72.9
9/32	.2812	.0621	133.2	103.2	90.9	84.3	73.
L	.290	.0660	142.	110.	96.6	89.6	77.6
M	.295	.0683	147.	113.	99.9	92.7	80.3
19/64	.2968	.0692	148.	115.	101.	93.9	81.3
N	.302	.0716	154.	119.	105.	97.2	84.1
5/16	.3125	.0767	165.	127.	112.	104.	90.1
O	.316	.0784	168.	130.	115.	106.	92.1
P	.323	.0820	176.	136.	120.	111.	96.4
21/64	.3281	.0846	182.	141.	124.	115.	99.4
Q	.332	.0866	186.	144.	127.	118.	102.
R	.339	.0901	193.	150.	132.	122.	106.
11/32	.3437	.0928	199.	154.	136.	126.	109.
S	.348	.0950	204.	158.	139.	129.	112.
T	.358	.1005	216.	167.	147.	136.	118.
23/64	.3593	.1014	218.	169.	148.	138.	119.
U	.368	.1063	228.	177.	156.	144.	125.
3/8	.375	.1104	237.	184.	162.	150.	130.
V	.377	.1116	239.	185.	163.	151.	131.
W	.386	.1170	251.	194.	171.	159.	137.
25/64	.3906	.1198	257.	199.	175.	163.	141.
X	.397	.1236	265.	205.	181.	168.	145.
Y	.404	.1278	274.	212.	187.	173.	150.
13/32	.4062	.1296	278.	215.	190.	176.	152.
Z	.413	.1340	288.	223.	196.	182.	157.
27/64	.4219	.1398	300.	232.	205.	190.	164.
7/16	.4375	.1503	322.	250.	220.	204.	177.
29/64	.4531	.1613	346.	268.	236.	219.	190.
15/32	.4687	.1726	370.	287.	253.	234.	203.

**CAPACITY, CFH @ 1" W.C. PRESSURE DROP
AND COEFFICIENT OF DISCHARGE OF 1.0**

Drill Size	Dia. In.	Area	Natural Gas	Air	Propane/ Air	Propane	Butane
			0.60 Sp. Gr.	1.0 Sp. Gr.	1.29 Sp. Gr.	1.5 Sp. Gr.	2.0 Sp. Gr.
31/64	.4843	.1843	395.	306.	270.	250.	217.
1/2	.50	.1963	421.	326.	287.	266.	231.
33/64	.5156	.2088	448.	347.	306.	283.	245.
17/32	.5312	.2217	476.	368.	324.	301.	261.
35/64	.5468	.2349	504.	390.	344.	319.	276.
9/16	.5625	.2485	533.	413.	364.	337.	292.
37/64	.5781	.2625	563.	436.	384.	356.	308.
19/32	.5937	.2769	594.	460.	405.	376.	325.
39/64	.6093	.2916	626.	485.	427.	396.	343.
5/8	.625	.3068	658.	510.	449.	416.	361.
41/64	.6406	.3223	691.	536.	472.	437.	379.
21/32	.6562	.3382	725.	562.	495.	459.	397.
43/64	.6718	.3545	760.	589.	519.	481.	417.
11/16	.6875	.3712	796.	617.	543.	504.	436.
45/64	.7031	.3883	833.	645.	568.	527.	456.
23/32	.7187	.4057	870.	674.	594.	551.	477.
47/64	.7343	.4236	909.	704.	620.	575.	498.
3/4	.750	.44179	948.	734.	646.	599.	519.
49/64	.7656	.46040	988.	765.	674.	625.	541.
25/32	.7813	.47937	1029.	796.	701.	651.	563.
51/64	.7969	.49873	1070.	829.	730.	677.	586.
13/16	.8125	.51849	1112.	862.	759.	704.	609.
53/64	.8281	.53862	1156.	895.	788.	731.	633.
27/32	.8438	.55914	1200.	929.	818.	759.	657.
55/64	.8594	.5800	1244.	964.	849.	787.	682.
7/8	.8750	.60132	1290.	999.	880.	816.	707.
29/32	.9062	.64504	1384.	1072.	944.	875.	758.
15/16	.9375	.69029	1481.	1147.	1010.	937.	811.
31/32	.9688	.73708	1581.	1225.	1079.	1000.	866.
1	1.0	.7854	1685.	1305.	1149.	1066.	923.
1-1/16	1.063	.88664	1902.	1474.	1297.	1203.	1042.
1-1/8	1.125	.99402	2133.	1652.	1455.	1349.	1168.
1-3/16	1.188	1.1075	2376.	1841.	1621.	1503.	1302.
1-1/4	1.250	1.2272	2633.	2040.	1796.	1665.	1442.
1-5/16	1.313	1.3530	2903.	2249.	1980.	1836.	1590.
1-3/8	1.375	1.4849	3186.	2468.	2173.	2015.	1745.
1-1/2	1.5	1.7671	3791.	2937.	2586.	2398.	2077.
1-9/16	1.563	1.9174	4114.	3187.	2806.	2602.	2253.
1-5/8	1.625	2.0739	4450.	3447.	3035.	2814.	2437.
1-11/16	1.688	2.2365	4799.	3717.	3273.	3035.	2628.
1-3/4	1.75	2.4053	5161.	3998.	3520.	3264.	2827.
1-13/16	1.813	2.5802	5536.	4288.	3776.	3501.	3032.
1-7/8	1.875	2.7612	5924.	4589.	4040.	3747.	3245.
1-15/16	1.938	2.9498	6329.	4903.	4316.	4003.	3467.
2	2.0	3.1416	6741.	5221.	4597.	4263.	3692.
2-1/8	2.125	3.5466	7610.	5894.	5190.	4813.	4168.
2-1/4	2.250	3.9761	8531.	6608.	5818.	5396.	4673.
2-3/8	2.375	4.4301	9505.	7363.	6483.	6012.	5206.
2-1/2	2.50	4.9087	10532.	8158.	7183.	6661.	5769.
2-5/8	2.625	5.4119	11612.	8995.	7919.	7344.	6360.
2-3/4	2.75	5.9396	12744.	9872.	8691.	8060.	6980.
2-7/8	2.875	6.4918	13929.	10789.	9499.	8809.	7629.

ORIFICE CAPACITY TABLES FOR HIGH PRESSURE GASES

These tables list compressible flows of high pressure gases through orifices and spuds. They are based on an orifice pressure drop of 10 psi and a coefficient of discharge (C_d) of 1.0. They also assume the gas is discharging to a region of atmospheric pressure.

To determine flow through an orifice of a known diameter:

1. Locate the orifice diameter in the left-hand column of the table.
2. Read across to the column corresponding to the gas being measured. This is the uncorrected flow.
3. Multiply this flow by the coefficient of discharge of the orifice. (see page 4)
4. Correct this flow to the pressure actually measured ahead of the orifice (P) using the following relationship:

$$Q_p = Q_{10} \frac{P + 14.7}{24.7}$$

Where Q_p is the unknown flow

Q_{10} is the flow at 10 psig from the table

Example: What is the flow of propane – air mixture through a 3/64" diameter jet with a 15° angle of convergence at 35 psig?

From the table, uncorrected propane – air flow through a 3/64" orifice is 41 scfh at 10 psig.

C_d for 15° convergent jet is 0.94 (page 4), so corrected flow is $41 \times 0.94 = 38.5$ scfh at 10 psig.

Corrected flow for 35 psig pressure, per the equation above, is

$$Q_p = 38.5 \frac{35 + 14.7}{24.7} = 77.5 \text{ scfh}$$

To determine the orifice size to handle a known flow at a specified pressure drop, reverse the process:

1. Correct the known flow to a pressure drop of 10 psig, using the equation above.
2. Divide the flow by the orifice coefficient.
3. In the orifice table, locate the column for the gas under consideration. In this column, locate the flow closest to the corrected value found in step 2.
4. Read to the left to find the corrected orifice size.

Example: Size an airjet with a convergent inlet of 15°. Required flow is 450 scfh at 20 psig inlet pressure.

Per the equation above,

$$Q_p = Q_{10} \frac{P + 14.7}{24.7}, \text{ or } Q_{10} = Q_p \frac{24.7}{P + 14.7}$$

Substituting the numbers for this case:

$$Q_{10} = 450 \frac{24.7}{20 + 14.7} = 320 \text{ scfh}$$

From page 4, C_d for a 15° convergent nozzle is 0.94, so corrected flow is

$$320 \div 0.94 = 340 \text{ scfh.}$$

Locate 340 scfh in the air column of the orifice table. Closest value is 341 scfh, which requires a 1/8" diameter jet.

CAPACITY, SCFH @ 10 PSI PRESSURE DROP, DISCHARGING TO ATMOSPHERE, WITH COEFFICIENT OF DISCHARGE OF 1.0

Drill Size	Area Sq. In.	Natural Gas 0.60 Sp. Gr.	Air 1.0 Sp. Gr.	Propane/Air 1.29 Sp. Gr.	Propane 1.5 Sp. Gr.	Butane 2.0 Sp. Gr.	
1/64	80	.000143	4.9	3.8	3.3	3.1	2.7
	79	.000165	5.6	4.3	3.8	3.5	3.0
	—	.00019	6.6	5.1	4.5	4.2	3.6
	78	.00020	7.0	5.4	4.8	4.4	3.8
	77	.00025	9.2	7.1	6.3	5.8	5.0
1/32	76	.00031	10.8	8.4	7.4	6.9	5.9
	75	.00035	11.9	9.2	8.1	7.5	6.53
	74	.00040	13.6	10.5	9.2	8.6	7.4
	73	.00045	15.6	12.1	10.7	9.9	8.6
	72	.00049	17.0	13.2	11.6	10.8	9.3
	71	.00053	18.5	14.3	12.6	11.7	10.1
1/16	70	.00062	21	16.4	14.4	13.4	11.6
	69	.00067	23	18.1	15.9	14.8	12.8
	68	.00075	26	20	17.6	16.3	14.1
	—	.00076	27	21	18.5	17.1	14.8
	67	.00080	28	22	19.4	18.0	15.6
	66	.00086	30	23	20	18.8	16.3
	65	.00096	34	26	23	21	18.4
1/8	64	.00102	35	27	24	22	19.1
	63	.00108	37	29	26	24	20
	62	.00113	40	31	27	25	22
	61	.00119	41	32	28	26	23
60	.00126	44	34	30	28	24	

**CAPACITY, SCFH @ 10 PSI PRESSURE DROP, DISCHARGING TO
ATMOSPHERE, WITH COEFFICIENT OF DISCHARGE OF 1.0 (Cont'd)**

Drill Size	Area Sq. In.	Natural Gas 0.60 Sp. Gr.	Air 1.0 Sp. Gr.	Propane/Air 1.29 Sp. Gr.	Propane 1.5 Sp. Gr.	Butane 2.0 Sp. Gr.
59	.00132	45	35	31	29	25
58	.00138	48	37	33	30	26
57	.00145	52	40	35	33	28
56	.00170	59	46	41	38	33
3/64 —	.00173	61	47	41	38	33
55	.00210	75	58	51	47	41
54	.00230	84	65	57	53	46
53	.00280	98	76	67	62	54
1/16 —	.00310	108	84	74	69	59
52	.00320	112	87	77	71	62
51	.00350	124	96	85	78	68
50	.00380	136	105	92	86	74
49	.00420	147	114	100	93	81
48	.00430	160	124	109	101	88
5/64 —	.00480	169	131	115	107	93
47	.00490	172	133	117	109	94
46	.00510	182	141	124	115	100
45	.00530	187	145	128	118	103
44	.00580	205	159	140	130	112
43	.00620	219	170	150	139	120
3/32 (42)	.00690	243	188	166	154	133
41	.00720	244	189	166	154	134
40	.00750	266	206	181	168	146
39	.00780	275	213	188	174	151
38	.00810	285	221	195	180	156
37	.00850	300	232	204	189	164
36	.00900	315	244	215	199	173
7/64 —	.00940	332	257	226	210	182
35	.00950	336	260	229	212	184
34	.00970	342	265	233	216	187
33	.01000	354	274	241	224	194
32	.01060	374	290	255	237	205
31	.01130	400	310	273	253	219
1/8 —	.01230	440	341	300	278	241
30	.01300	458	355	313	290	251
29	.01450	514	398	350	325	281
28	.01550	550	426	375	348	301
9/64 —	.01560	553	428	377	349	303
27	.01630	572	443	390	362	313
26	.01740	599	464	409	379	328
25	.01750	621	481	423	393	340
24	.01810	642	497	437	406	351
23	.01860	660	511	450	417	361
5/32 —	.01920	678	525	462	429	371
22	.01930	684	530	467	433	375
21	.01980	702	544	479	444	385
20	.02030	728	564	497	461	399
19	.02160	766	593	522	484	419
18	.02260	800	620	546	506	438
11/64 —	.02320	822	637	561	520	450
17	.02350	830	643	566	525	455
16	.02460	871	675	594	551	477
15	.02540	904	700	616	572	495
14	.02600	920	713	628	582	503
13	.02690	951	737	649	602	521
3/16 —	.02760	976	756	666	617	534
12	.02805	993	769	677	628	544

**CAPACITY, SCFH @ 10 PSI PRESSURE DROP, DISCHARGING TO
ATMOSPHERE, WITH COEFFICIENT OF DISCHARGE OF 1.0 (Cont'd)**

Drill Size	Area Sq. In.	Natural Gas 0.60 Sp. Gr.	Air 1.0 Sp. Gr.	Propane/Air 1.29 Sp. Gr.	Propane 1.5 Sp. Gr.	Butane 2.0 Sp. Gr.
11	.02865	1015	786	692	642	556
10	.02940	1041	806	710	658	570
9	.03020	1066	826	727	674	584
8	.03110	1100	852	750	696	602
7	.03160	1122	869	765	710	614
13/64 —	.03240	1148	889	783	726	629
6	.03270	1155	895	788	731	633
5	.03320	1172	908	799	741	642
4	.03430	1216	942	829	769	666
3	.03560	1263	978	861	799	692
7/32 —	.03760	1327	1028	905	839	727
2	.03840	1361	1054	928	861	745
1	.04090	1447	1121	987	915	793
A	.04300	1523	1180	1039	963	834
15/64 —	.04310	1529	1184	1042	967	837
B	.04440	1571	1217	1072	994	861
C	.04600	1627	1260	1109	1029	891
D	.04750	1686	1306	1150	1066	923
1/4 E	.04910	1738	1346	1185	1099	952
F	.05190	1836	1422	1252	1161	1006
G	.05350	1891	1465	1290	1196	1036
17/64 —	.05540	1960	1518	1336	1239	1073
H	.05560	1969	1525	1343	1245	1078
I	.05800	2054	1591	1401	1299	1125
J	.06010	2128	1648	1451	1346	1165
K	.06200	2192	1698	1495	1386	1201
9/32 —	.06210	2200	1704	1500	1391	1205
L	.06600	2337	1810	1594	1478	1280
M	.06830	2418	1873	1649	1529	1324
19/64 —	.06920	2448	1896	1669	1548	1341
N	.07160	2534	1963	1728	1603	1388
5/16 —	.07670	2714	2102	1851	1716	1486
O	.07840	2782	2155	1897	1760	1524
P	.08200	2893	2241	1973	1830	1585
21/64 —	.08460	2996	2321	2044	1895	1641
Q	.08660	3065	2374	2090	1938	1679
R	.09010	3193	2473	2177	2019	1749
11/32 —	.09280	3283	2543	2239	2076	1798
S	.09500	3373	2613	2301	2134	1848
T	.10050	3553	2752	2423	2247	1946
23/64 —	.10140	3595	2785	2452	2274	1969
U	.10630	3775	2924	2574	2387	2068
3/8 —	.11040	3912	3030	2668	2474	2143
V	.11160	3959	3067	2700	2504	2169
W	.11700	4135	3203	2820	2615	2265
25/64 —	.11980	4237	3282	2890	2680	2321
X	.12360	4374	3388	2983	2766	2396
Y	.12780	4537	3514	3094	2869	2485
13/32 —	.12960	4580	3548	3124	2897	2509
Z	.13400	4751	3680	3240	3005	2602
27/64 —	.13980	4943	3829	3371	3126	2708
7/16 —	.15030	5307	4111	3620	3357	2907
29/64 —	.16130	5714	4426	3897	3614	3130
15/32 —	.17260	6121	4741	4452	3871	3352
31/64 —	.18430	6527	5056	4448	4128	3575
1/2 —	.19630	6977	5204	4758	4412	3821

PIPING PRESSURE LOSSES FOR LOW PRESSURE AIR

Inches w.c. per 100 ft. of Schedule 40 pipe

Scfh Air	1/2"	3/4"	1"	1-1/4"	1-1/2"	2"	2-1/2"	3"
40	0.3	—	—	—	—	—	—	—
50	0.5	—	—	—	—	—	—	—
100	2.1	0.5	—	—	—	—	—	—
200	8.4	1.9	0.5	—	—	—	—	—
300	18.9	4.2	1.2	0.3	—	—	—	—
400	—	7.5	2.1	0.5	—	—	—	—
500	—	11.8	3.3	0.8	0.4	—	—	—
600	—	16.9	4.7	1.1	0.5	—	—	—
700	—	—	6.4	1.5	0.7	—	—	—
800	—	—	8.3	2.0	0.9	—	—	—
900	—	—	10.5	2.5	1.1	0.3	—	—
1,000	—	—	13.0	3.1	1.4	0.4	—	—
1,500	—	—	—	7.0	3.2	0.8	0.3	—
2,000	—	—	—	12.4	5.6	1.4	0.6	—
3,000	—	—	—	—	12.6	3.2	1.3	0.4
4,000	—	—	—	—	—	5.8	2.2	0.8
5,000	—	—	—	—	—	9.0	3.5	1.2
6,000	—	—	—	—	—	13.0	5.0	1.7
7,000	—	—	—	—	—	17.6	6.9	2.3
8,000	—	—	—	—	—	—	9.0	3.0
9,000	—	—	—	—	—	—	11.3	3.8
10,000	—	—	—	—	—	—	14.0	4.7
12,000	—	—	—	—	—	—	20.2	6.8
14,000	—	—	—	—	—	—	—	9.2
16,000	—	—	—	—	—	—	—	12.0
18,000	—	—	—	—	—	—	—	15.2
20,000	—	—	—	—	—	—	—	18.8

Scfh Air	4"	6"	8"	10"	12"	14"	16"	18"
4,000	—	—	—	—	—	—	—	—
6,000	0.4	—	—	—	—	—	—	—
8,000	0.7	—	—	—	—	—	—	—
10,000	1.1	—	—	—	—	—	—	—
12,000	1.6	—	—	—	—	—	—	—
14,000	2.2	0.3	—	—	—	—	—	—
16,000	2.8	0.3	—	—	—	—	—	—
18,000	3.6	0.4	—	—	—	—	—	—
20,000	4.4	0.5	—	—	—	—	—	—
25,000	6.9	0.8	—	—	—	—	—	—
30,000	9.9	1.2	0.3	—	—	—	—	—
35,000	13.5	1.6	0.4	—	—	—	—	—
40,000	17.6	2.1	0.5	—	—	—	—	—
50,000	—	3.3	0.7	—	—	—	—	—
60,000	—	4.7	1.0	0.3	—	—	—	—
70,000	—	6.4	1.4	0.5	—	—	—	—
80,000	—	8.3	1.9	0.6	—	—	—	—
90,000	—	10.5	2.4	0.8	0.3	—	—	—
100,000	—	13.0	2.9	0.9	0.4	—	—	—
120,000	—	18.7	4.2	1.3	0.5	0.3	—	—
140,000	—	—	5.7	1.8	0.7	0.4	—	—
160,000	—	—	7.4	2.4	0.9	0.5	0.3	—
180,000	—	—	9.4	3.0	1.2	0.7	0.3	—
200,000	—	—	11.6	3.7	1.4	0.8	0.4	—
250,000	—	—	18.2	5.8	2.2	1.3	0.6	0.3
300,000	—	—	—	8.4	3.2	1.9	0.9	0.5
350,000	—	—	—	11.4	4.4	2.5	1.3	0.6
400,000	—	—	—	14.9	5.7	3.3	1.6	0.8
450,000	—	—	—	18.8	7.2	4.2	2.1	1.1
500,000	—	—	—	—	9.0	5.2	2.6	1.3
550,000	—	—	—	—	10.8	6.2	3.1	1.6
600,000	—	—	—	—	12.9	7.4	3.7	1.9
650,000	—	—	—	—	15.1	8.7	4.4	2.2
700,000	—	—	—	—	17.5	10.1	5.0	2.5
800,000	—	—	—	—	—	13.2	6.6	3.3
900,000	—	—	—	—	—	16.7	8.3	4.2
1,000,000	—	—	—	—	—	20.6	10.3	5.2
1,100,000	—	—	—	—	—	—	12.5	6.3
1,200,000	—	—	—	—	—	—	14.8	7.5
1,300,000	—	—	—	—	—	—	17.4	8.8
1,400,000	—	—	—	—	—	—	20.2	10.2
1,600,000	—	—	—	—	—	—	—	13.3
1,800,000	—	—	—	—	—	—	—	16.8
2,000,000	—	—	—	—	—	—	—	20.8

PIPING PRESSURE LOSSES FOR LOW PRESSURE NATURAL GAS

Inches w.c. per 100 ft. of Schedule 40 pipe

Scfh Nat. Gas	3/8"	1/2"	3/4"	1"	1-1/4"	1-1/2"	2"
25	0.3	—	—	—	—	—	—
50	1.1	0.3	—	—	—	—	—
75	2.5	0.7	—	—	—	—	—
100	4.4	1.2	0.3	—	—	—	—
125	6.9	1.9	0.4	—	—	—	—
150	9.9	2.8	0.6	—	—	—	—
175	13.5	3.8	0.9	—	—	—	—
200	17.6	5.0	1.1	0.3	—	—	—
300	—	11.2	2.5	0.7	—	—	—
400	—	19.8	4.5	1.2	0.3	—	—
500	—	—	7.0	1.9	0.5	—	—
600	—	—	10.1	2.8	0.7	0.3	—
700	—	—	13.8	3.8	0.9	0.4	—
800	—	—	18.0	4.9	1.2	0.5	—
900	—	—	—	6.3	1.5	0.7	—
1,000	—	—	—	7.7	1.9	0.8	—
1,500	—	—	—	17.4	4.2	1.9	0.5
2,000	—	—	—	—	7.5	3.3	0.9
2,500	—	—	—	—	11.8	5.2	1.3
3,000	—	—	—	—	16.9	7.5	1.9
4,000	—	—	—	—	—	13.2	3.4
5,000	—	—	—	—	—	20.7	5.4
6,000	—	—	—	—	—	—	7.7
7,000	—	—	—	—	—	—	10.5
8,000	—	—	—	—	—	—	13.8
9,000	—	—	—	—	—	—	17.4

PIPING PRESSURE LOSSES FOR LOW PRESSURE NATURAL GAS

Inches w.c. per 100 ft. of Schedule 40 pipe

Scfh Nat. Gas	2-1/2"	3"	4"	6"	8"
2,000	0.3	—	—	—	—
2,500	0.5	—	—	—	—
3,000	0.8	0.3	—	—	—
4,000	1.3	0.4	—	—	—
5,000	2.1	0.7	—	—	—
6,000	3.0	1.0	—	—	—
7,000	4.1	1.4	0.3	—	—
8,000	5.4	1.8	0.4	—	—
9,000	6.8	2.3	0.6	—	—
10,000	8.4	2.8	0.7	—	—
12,000	12.1	4.0	1.0	—	—
14,000	16.4	5.5	1.4	—	—
16,000	—	7.2	1.8	—	—
18,000	—	9.1	2.2	0.3	—
20,000	—	11.2	2.8	0.3	—
22,000	—	13.6	3.3	0.4	—
24,000	—	16.1	4.0	0.4	—
26,000	—	18.9	4.7	0.5	—
28,000	—	—	5.4	0.6	—
30,000	—	—	6.2	0.7	—
35,000	—	—	8.5	1.0	—
40,000	—	—	11.0	1.2	0.3
45,000	—	—	14.0	1.6	0.3
50,000	—	—	17.3	2.0	0.4
55,000	—	—	20.9	2.4	0.5
60,000	—	—	—	2.8	0.6
70,000	—	—	—	3.8	0.8

Scfh Nat. Gas	Inches w.c. per 100 ft of Schedule 40 pipe	
	6"	8"
80,000	5.0	1.1
90,000	6.3	1.4
100,000	7.8	1.7
110,000	9.4	2.1
120,000	11.2	2.4
130,000	13.2	2.9
140,000	15.3	3.3
150,000	17.6	3.8
200,000	—	6.8
250,000	—	10.6
300,000	—	15.3

HIGH PRESSURE (COMPRESSIBLE) FLOW OF NATURAL GAS IN PIPES

Flows in table are scfh of 0.6 sp. gr. natural gas

Pipe Size, Inches	Inlet Pressure, PSIG	Pressure Drop Per 100 Equivalent Feet of Pipe as a Percentage of Inlet Pressure				
		2%	4%	6%	8%	10%
1	2	340	480	590	680	760
	5	590	840	1030	1180	1320
	10	930	1320	1610	1850	2070
	20	1570	2210	2700	3110	3470
	50	3380	4770	5820	6690	7450
1-1/4	2	710	1010	1230	1420	1590
	5	1230	1740	2130	2450	2740
	10	1950	2760	3370	3880	4330
	20	3260	4600	5620	6470	7210
	50	7040	9910	12,090	13,910	15,490
1-1/2	2	1080	1530	1870	2160	2410
	5	1860	2630	3220	3710	4140
	10	2940	4160	5080	5850	6530
	20	4930	6960	8490	9780	10,900
	50	10,640	15,000	18,290	21,040	23,430
2	2	2100	2980	3640	4200	4700
	5	3630	5120	6270	7230	8070
	10	5740	8090	9890	11,400	12,720
	20	9610	13,550	16,540	19,050	21,230
	50	20,720	29,190	35,610	40,960	45,610
2-1/2	2	3390	4810	5880	6780	7580
	5	5850	8260	10,100	11,650	13,010
	10	9240	13,040	15,940	18,370	20,500
	20	15,480	21,840	26,660	30,700	34,220
	50	33,400	47,050	57,400	66,010	73,510
3	2	6060	8590	10,500	12,120	13,540
	5	10,450	14,760	18,050	20,820	23,240
	10	16,510	23,290	28,480	32,810	36,610
	20	27,650	38,990	47,620	54,820	61,110
	50	59,640	84,010	102,500	117,880	131,270
4	2	12,480	17,690	21,620	24,960	27,890
	5	21,520	30,400	37,180	42,890	47,880
	10	34,000	47,980	58,650	67,580	75,410
	20	56,960	80,320	98,090	112,930	125,880
	50	122,850	173,070	211,140	242,840	270,420
6	2	37,250	52,800	64,560	74,510	83,270
	5	64,240	90,760	111,010	128,040	142,950
	10	101,520	143,260	175,120	201,780	225,150
	20	170,060	239,810	292,840	337,150	375,820
	50	366,770	516,680	630,360	724,970	807,320

EQUIVALENT LENGTHS OF STANDARD PIPE FITTINGS & VALVES

VALVES FULLY OPEN

Pipe Size	I.D. Inches	Gate	Globe	Angle	Swing Check	90° Elbow	45° Elbow	90° Tee, Flow Through Run	90° Tee, Flow Through Branch
1/2"	0.622	0.35	18.6	9.3	4.3	1.6	0.78	1.0	3.1
3/4"	0.824	0.44	23.1	11.5	5.3	2.1	0.97	1.4	4.1
1"	1.049	0.56	29.4	14.7	6.8	2.6	1.23	1.8	5.3
1-1/4"	1.380	0.74	38.6	19.3	8.9	3.5	1.6	2.3	6.9
1-1/2"	1.610	0.86	45.2	22.6	10.4	4.0	1.9	2.7	8.0
2"	2.067	1.10	58	29	13.4	5.2	2.4	3.5	10.4
2-1/2"	2.469	1.32	69	35	15.9	6.2	2.9	4.1	12.4
3"	3.068	1.60	86	43	19.8	7.7	3.6	5.1	15.3
4"	4.026	2.1	112	56	26.8	10.1	5.4	6.7	20.1
6"	6.065	2.6	140	70	40.4	15.2	8.1	10.1	30.3

Equivalent lengths are for standard screwed fittings and for screwed, flanged, or welded valves relative to schedule 40 steel pipe.

SIMPLIFIED SELECTION OF AIR, GAS AND MIXTURE PIPING SIZE

Air, gas and mixture piping systems should be sized to deliver flow at a uniform pressure distribution and without excessive pressure losses in transit.

Two factors cause air pressure loss and consequent pressure variations:

- 1) Friction in piping and bends, and
- 2) Velocity pressure losses due to changes in direction.

In combustion work, piping runs are usually short (under 50 ft.), but often have many bends. By assuming that all velocity pressure is lost or dissipated at each change of direction and by using a pipe size to give a very low velocity pressure, other losses can be disregarded. In general, a velocity pressure of 0.3 to 0.5" w.c. satisfies this need. This is equivalent to air velocities of about 2200 to 2800 ft/minute. For other gases, this velocity is inversely proportional to their gravities; consequently, higher velocities can be tolerated with natural gas, but propane and butane piping should be sized for lower velocities than air.

The accuracy of orifice meters is also sensitive to pipe velocity, so every effort should be made to keep velocity pressure below 0.3" w.c. in metering runs.

The graph below shows the relationship between velocity, velocity pressure and flow for various pipe sizes handling air, natural gas, propane, and butane. Because the specific gravity of most air-gas mixtures is close to that of air, mixture piping can be sized the same as air piping. The error will be insignificant.

Example: A burner requires 10,000 cfm air at a static pressure of 13" w.c. The blower supplying this burner develops 15" w.c. static pressure. Piping between the two will run 15 feet, including four 90° bends. What size piping is required?

Solution: Total pressure available for piping losses is 15" w.c. - 13" w.c. = 2" w.c.

This allows a velocity pressure loss of:
 $2 \div 4 = 0.5$ " w.c. for each of the four elbows.

Under the "Air" column on the left-hand side of the P_v graph, locate 0.5" w.c. velocity pressure. This is equivalent to about 2800 ft/minute air velocity. Locate the intersection of the 2800 ft/minute line and the 10,000 cfm line, then drop down to the first curve below this point, in this case, 4" pipe. This is the pipe size that should be used.

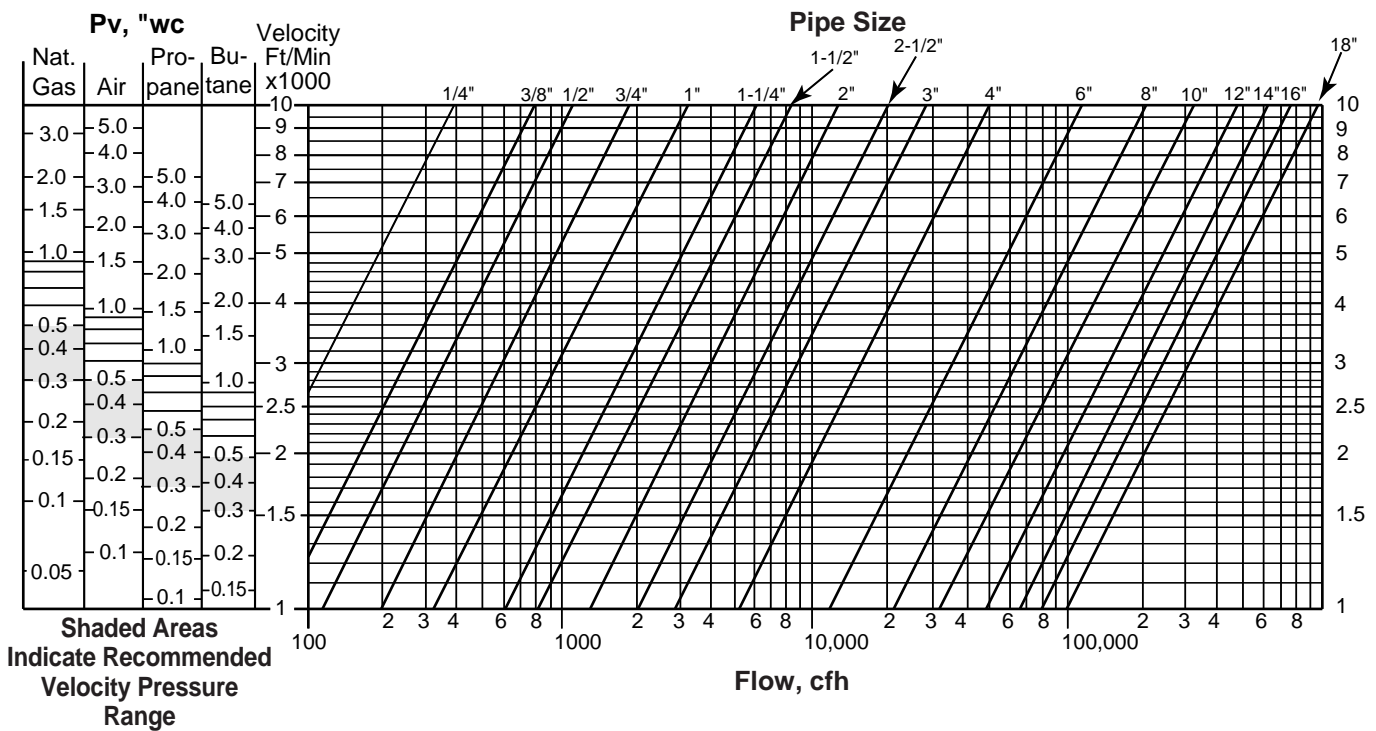

QUICK METHOD FOR SIZING AIR PIPING

If pipe sizing charts or tables aren't available, you can quickly estimate the maximum air flow capacity of a pipe with these simple equations:

$$\text{Maximum cfm air} = (\text{Nominal pipe size})^2 \times 1000$$

The result will correspond to a velocity pressure of about 0.5" w.c., the maximum recommended for low pressure air systems.

$$\text{Optimum cfm air} = (\text{Nominal pipe size})^2 \times 750$$

This will produce a flow rate equivalent to about 0.3" w.c. velocity pressure.

Example: What is the maximum air flow rate for 2 1/2" pipe?

$$(2\frac{1}{2})^2 = 6.25$$

$$6.25 \times 1000 = 6,250 \text{ cfm air.}$$

SIZING BRANCH PIPING BY THE EQUAL AREA METHOD

The equal area method of sizing pipe manifolds is based on maintaining constant total cross-sectional area in all portions of a piping train, regardless of the number of branches in each portion. In the sketch below, the equal area method requires that:
 Area of X = 2 times area of Y = 6 times area of Z.

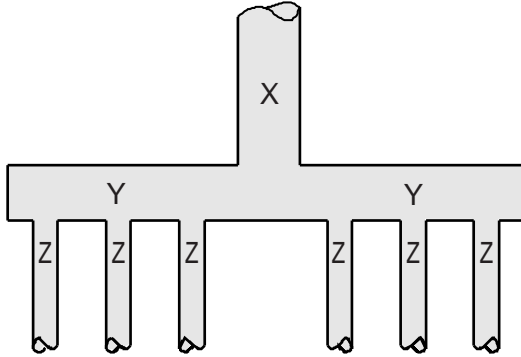

The advantage of this method is that once the size of the smallest branch has been determined, via velocity pressures or any other valid method, the remainder of the piping system can be correctly sized without any additional calculations. Remember, however, that if the calculation of the smallest branches is in error, the entire system will be incorrectly sized.

To use the table below, read across from the pipe size of the smallest branch in the manifold (Z in the sketch at left) and down from the number of these branches. At the intersection, find the recommended size pipe to feed these branches. For example, if Z is 3/4", Y should be 1 1/4" and X should be 2" pipe.

Size of Branch Connection	Number of Branch Connections							
	1	2	3	4	5	6	7	8
1/4	1/4	3/8	1/2	3/4	3/4	1	1	1
3/8	3/8	3/4	3/4	1	1-1/4	1-1/4	1-1/4	1-1/4
1/2	1/2	3/4	1	1	1	1-1/4	1-1/2	2
3/4	3/4	1-1/4	1-1/4	1-1/2	2	2	2	2-1/2
1	1	1-1/4	2	2	2-1/2	2-1/2	3	3
1-1/4	1-1/4	2	2-1/2	3	3	4	4	4
1-1/2	1-1/2	2-1/2	3	3	4	4	4	6
2	2	3	4	4	6	6	6	6
2-1/2	2-1/2	4	4	6	6	6	6	6
3	3	4	6	6	8	8	8	8
4	4	6	8	8	10	10	10	12
6	6	8	10	12	14	16	18	18
8	8	12	14	16	18	20	20 or 24	24
10	10	14	18	20	24	24	30	30

C_v FLOW FACTOR CONVERSIONS

C_v, flow factor, is defined as the full flow capacity of a valve expressed in gpm of 60°F water at 1 psi pressure drop. This rating is determined by actual flow test. To convert C_v to actual flow capacity for gases, use the graph below.

Locate C_v at the left, read across to the appropriate curve and then down to obtain flow capacity at 1" w.c. pressure drop. For drops other than 1" w.c., multiply the flow by the square root of the pressure drop.

For conditions other than 14.7 psia and 60°F, use this formula:

$$Q = 1360C_v \sqrt{\frac{(P_1 - P_2) P_2}{GT}}$$

where

Q = SCFH

P₁ = Inlet pressure, psia

P₂ = Outlet pressure, psia

T = Absolute flowing temperature (°F + 460)

G = Specific gravity of gas

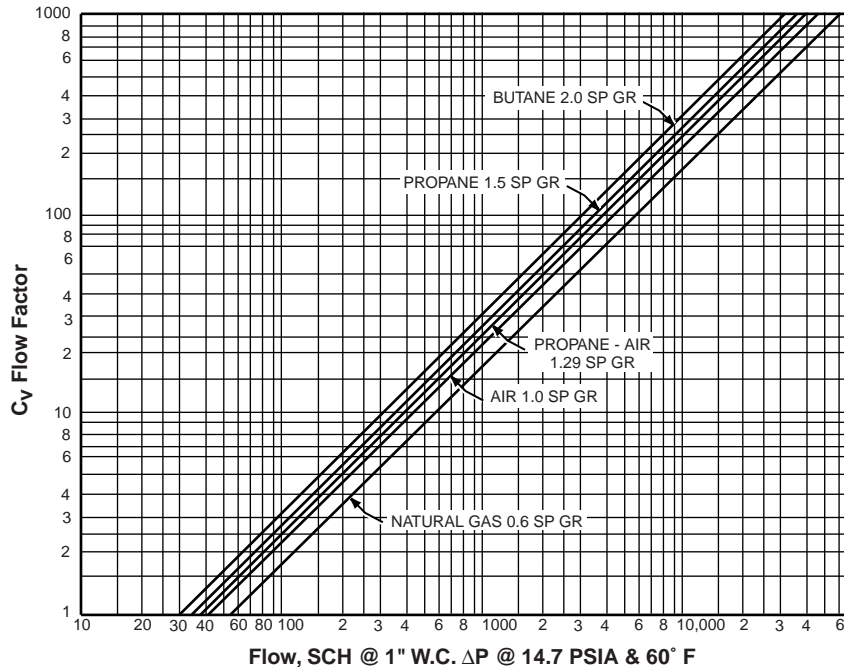

DUCT VELOCITY & FLOW MEASUREMENTS

The total pressure of an air stream flowing in a duct is the sum of the static or bursting pressure exerted upon the side-walls of the duct and the impact or velocity pressure of the moving air. Through the use of a pitot tube connected differentially to a manometer, the velocity pressure alone is indicated and the corresponding air velocity determined.

For accuracy of plus or minus 2%, as in laboratory applications, extreme care is required and the following precautions should be observed:

1. Duct diameter 4" or greater.
2. Make an accurate traverse per sketch below and average the readings.
3. Provided smooth, straight duct sections 10 diameters in length both upstream and downstream from the pitot tube.
4. Provide an egg crate type straightener upstream from the pitot tube.

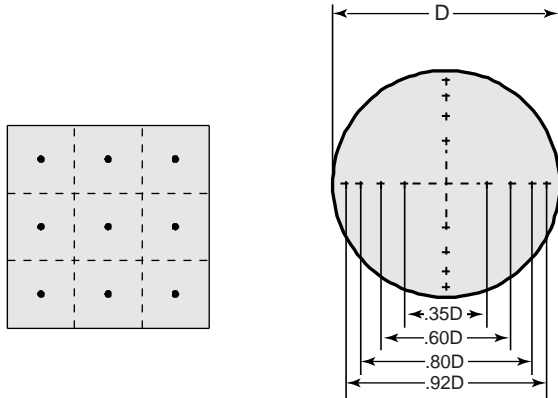

In making an air velocity check select a location as suggested above, connect tubing leads from both pitot tube connections to the manometer and insert in the duct with the tip directed into the air stream. If the manometer shows a minus indication reverse the tubes. With a direct reading manometer, air velocities will now be shown in feet per minute. In other types, the manometer will read velocity pressure in inches of water and the corresponding velocity will be found from the curves below. If circumstances do not permit an accurate traverse, center the pitot tube in the duct, determine the center velocity and multiply by a factor of .9 for the approximate average velocity. Field tests run in this manner should be accurate within plus or minus 5%.

The velocity indicated is for dry air at 70°F., 29.9" Barometric Pressure and a resulting density of .075#/ cu. ft. For air at a temperature other than 70°F. refer to the curves below. For other variations from these conditions, corrections may be based upon the following data:

$$\text{Air Velocity} = 1096.2 \sqrt{\frac{P_v}{D}}$$

where P_v = velocity pressure in inches of water
 D = Air density in #/cu. ft.

$$\text{Air Density} = 1.325 \times \frac{PB}{T}$$

where PB = Barometric Pressure in inches of mercury
 T = Absolute Temperature (indicated temperature plus 460)

Flow in cu. ft. per min. = Duct area in square feet x air velocity in ft. per min.

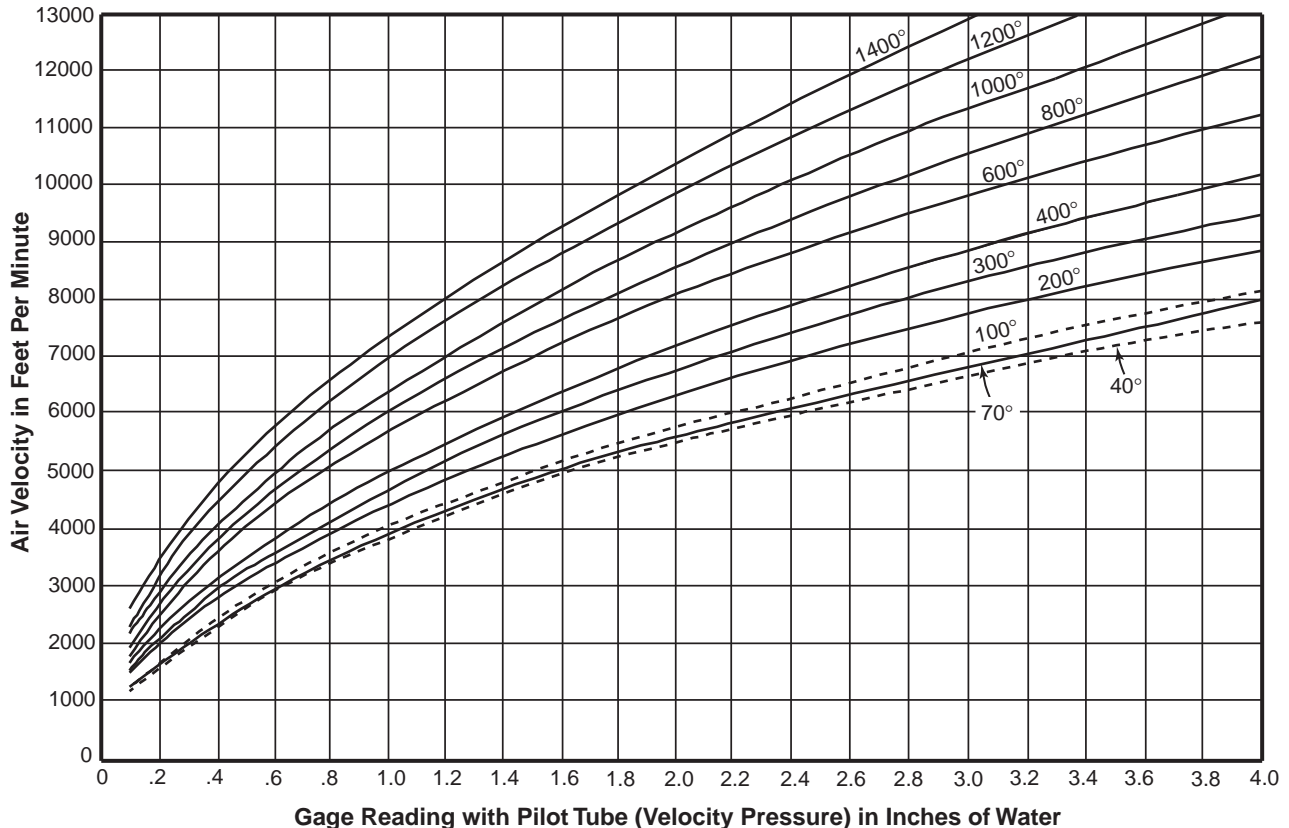

REPRINTED WITH PERMISSION OF F.W. DWYER MANUFACTURING CO., MICHIGAN CITY, INDIANA

CHAPTER 2 – FAN LAWS & BLOWER APPLICATION ENGINEERING

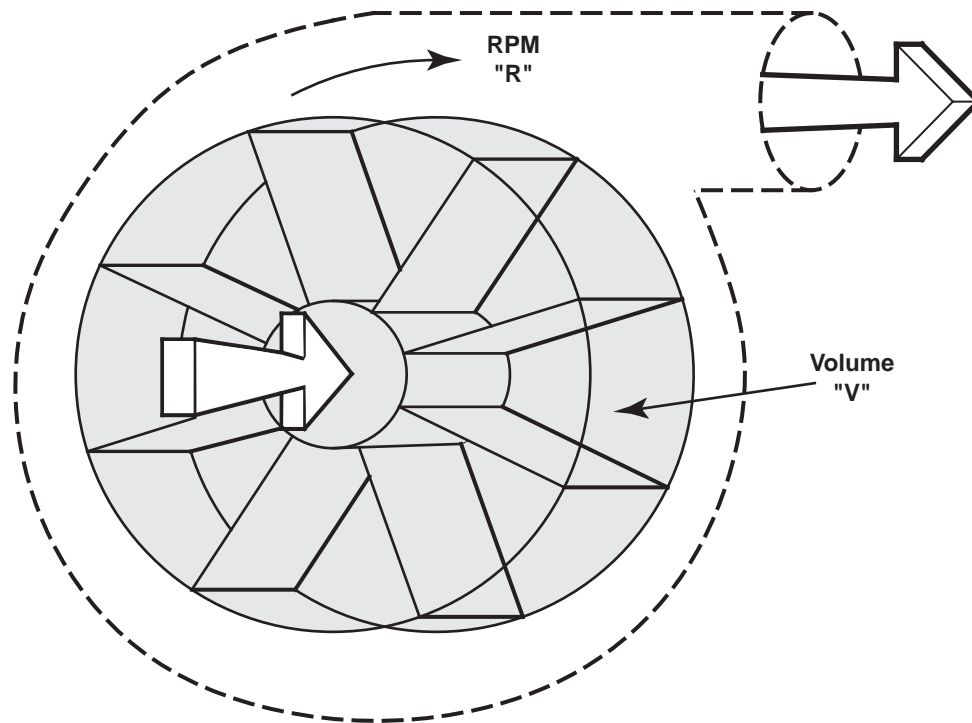

For blower wheel with eight segments, Theoretical Flow = $8 \times V \times R$

Combustion air blowers are normally rated in terms of standard cubic feet (scf) of air; that is, 70°F air at Sea Level (29.92" Hg) barometric pressure. Density of this air is 0.075 lb/cu ft, and its specific gravity is 1.0.

Although fuel/air ratios are usually stated in cubic feet of air per cubic foot or gallon of fuel, it's the weight of air per weight of fuel that's important. As long as air temperature and pressure are close to standard conditions, blower and burner sizing charts can be used without correction. However, if air temperature, gauge pressure or altitude change the density of air by any significant amount, blower ratings have to be corrected from actual cubic feet (acf) to standard cubic feet to insure the proper weight flow of air reaches the burner.

Centrifugal fans are basically constant volume devices; at a given rotational speed, they will deliver the same volume of air regardless of its density.

If, for example, a blower has a wheel made up of eight segments, each with a volume V , and the wheel is rotating at R rpm, the theoretical flow rating of the blower will be $8 \times V \times R$, because each fan wheel segment fills with air and empties itself once each revolution.

The actual volume delivered is strictly a function of the carrying capacity of the wheel and its speed. Cfm, whether it is standard (scfm) or actual (acfm) is the same. Consequently, if the density of air is reduced by temperature, pressure, or both, the blower will deliver a lower weight flow of air, even though the measured volume hasn't changed.

Air density also affects the pressure developed by the blower and its power consumption. Because air density is related to temperature, pressure, and altitude (barometric pressure) – see pages 20 and 21 – it is possible to relate blower performance to these factors with a set of relationships known as *fan laws*.

FAN LAWS

1. Effect of Blower Speed on Flow, Pressure and Power Consumption

a. Flow vs. Speed: The flow rate (V) changes in direct ratio to the speed (S)

$$\frac{V_2}{V_1} = \frac{S_2}{S_1}$$

Example: A blower operating at 1750 rpm (S_1) delivers 1000 cfm (V_1). How many cfm (V_2) will it deliver if speed is increased to 3500 rpm (S_2)?

$$V_2 = V_1 \times \frac{S_2}{S_1} = 1000 \times \frac{3500}{1750} = 2000 \text{ cfm}$$

b. Pressure vs. Speed: The pressure (P) changes as the square of the speed ratio (S)

$$\frac{P_2}{P_1} = \left(\frac{S_2}{S_1}\right)^2$$

Example: A blower operating at 1750 rpm (S_1) develops 1 psig (P_1) pressure. If speed is doubled to 3500 rpm (S_2), what is the new pressure (P_2)?

$$P_2 = P_1 \times \left(\frac{S_2}{S_1}\right)^2 = 1 \times \left(\frac{3500}{1750}\right)^2 = 1 \times (2)^2 = 1 \times 4 = 4 \text{ psig}$$

c. Horsepower vs. Speed: The horsepower (HP) consumed changes as the cube of the speed ratio (S)

$$\frac{HP_2}{HP_1} = \left(\frac{S_2}{S_1}\right)^3$$

Example: A blower operating at 1750 rpm (S_1) requires a 5 hp (HP_1) motor. How many horsepower (HP_2) will be required to handle a speed increase to 3500 rpm (S_2)?

$$HP_2 = HP_1 \times \left(\frac{S_2}{S_1}\right)^3 = 5 \times \left(\frac{3500}{1750}\right)^3 = 5 \times (2)^3 = 5 \times 8 = 40 \text{ hp}$$

Laws 1a, 1b and 1c are known as the 1-2-3 rule of centrifugal blowers. Volume increases in direct ratio, pressure as the square, and horsepower as the cube, of the speed ratio.

2. Effect of Air Density on Flow, Pressure, and Power Consumption.

a. Volume Flow vs. Density

Volume flow (cfm) remains constant regardless of density.

b. Weight Flow vs. Density: Weight flow (W) changes in direct ratio to the density (D) or specific gravity (G)

$$\frac{W_2}{W_1} = \frac{D_2}{D_1} = \frac{G_2}{G_1}$$

Example: A blower delivers 1500 lb/hr (20,000 cu ft/hr) (W_1) of air at standard conditions (density $D_1 = 0.075$ lb/cu ft). What will be the weight flow delivered if the air temperature is 250°F?

From page 21, air density (D_2) at 250°F is .056 lb/cu ft.

$$W_2 = W_1 \times \frac{D_2}{D_1} = 1500 \times \frac{.056}{.075} = 1120 \text{ lb/hr.}$$

c. Pressure vs. Density: Pressure (P) changes in direct proportion to density (D) or specific gravity (G).

$$\frac{P_2}{P_1} = \frac{D_2}{D_1} = \frac{G_2}{G_1}$$

Example: At sea level conditions ($G_1 = 1.0$), a blower develops 28" w.c. pressure (P_1). What pressure (P_2) will it develop at 4000 ft. altitude?

From page 20, air gravity (G_2) at 4000 ft is 0.86.

$$P_2 = P_1 \times \frac{G_2}{G_1} = 28 \times \frac{.86}{1.0} = 24.1" \text{ w.c.}$$

d. Horsepower vs. Density: Horsepower (HP) consumed changes in direct proportion to density (D) or specific gravity (G).

$$\frac{HP_2}{HP_1} = \frac{D_2}{D_1} = \frac{G_2}{G_1}$$

Example: A standard air (G_1) blower requires a 10 hp (HP_1) motor. What horsepower (HP_2) is required if this blower is to handle a gas of 0.5 specific gravity (G_2)?

The gravity of standard air is 1.0, so

$$HP_2 = HP_1 \times \frac{G_2}{G_1} = 10 \times \frac{0.5}{1.0} = 5 \text{ hp}$$

Re-rating blowers for nonstandard conditions

As fan laws 2b, 2c, and 2d show, blower weight flow, pressure, and horsepower all change in direct proportion to air density or gravity. While these relationships are important to know, it's usually more important to know how to select a blower to compensate for nonstandard conditions. The following example shows how it is done.

Example: A burner is rated a 1 million Btu/hr. at an air pressure of 20" w.c., including piping and control valve drops. If the burner is to be installed at 6000 feet altitude, select a blower that will permit the burner's input rating to be maintained.

Solution: Use the rule-of-thumb of 100 Btu per standard cubic foot of air to estimate blower flow requirements:

$$1,000,000 \text{ Btu/hr} \div 100 \text{ Btu/scf air} = 10,000 \text{ scfh air.}$$

This is the blower's standard (sea level) rating.

At 6,000 feet, the specific gravity of air is 0.80 (see page 20).

To maintain a weight flow of air through the burner equivalent to 10,000 scfh, the volume flow through the burner has to be increased to offset the air's lower density.

$$V_2 = V_1 \times \frac{G_1}{G_2} = 10,000 \text{ cfh} \times \frac{1.00}{0.80} = 12,500 \text{ cfh}$$

In other words, 12,500 cfh air at 6000 feet has the same weight as 10,000 cfh at sea level.

The pressure required now will be adjusted for the new air flow, taking into account the lower density of the air.

$$P_2 = P_1 \times \left(\frac{V_2}{V_1}\right)^2 = \left(\frac{V_2}{V_1}\right)^2 = \frac{G_1}{G_2}$$

$$P_2 = P_1 \times \frac{G_1}{G_2} = 20" \text{ w.c.} \times \frac{1.00}{0.80} = 25" \text{ w.c.}$$

Because the pressure generated by the blower decreases with air density, the sea level pressure rating has to be higher to compensate for the loss of outlet pressure at higher altitudes.

$$P_1 = P_2 \times \frac{G_1}{G_2} = 25" \text{ w.c.} \times \frac{1.00}{0.80} = 31.25" \text{ w.c.}$$

Therefore, the blower must be capable of delivery at least 12,500 cfh at 31.25" w.c. at sea level to satisfy the needs of the burner at 6000 feet altitude.

Blower horsepower requirements

Blower horsepower increases with the air flow delivered and the pressure developed. The four equations below can be used to predict blower horsepower consumption. They differ only in the flow and pressure units used. The term “efficiency” is the overall blower efficiency – a composite of fan, motor and drive train efficiencies – expressed as a decimal.

$$hp = \frac{scfm \times \text{"w.c.}}{6356 \times \text{efficiency}} \quad hp = \frac{scfm \times \text{osi}}{3670 \times \text{efficiency}}$$

$$hp = \frac{scfh \times \text{"w.c.}}{381,360 \times \text{efficiency}} \quad hp = \frac{scfh \times \text{osi}}{220,200 \times \text{efficiency}}$$

Blowers used as suction fans

When a blower is used as a suction device discharging to atmosphere, the amount of suction or vacuum developed can be calculated from this relationship:

$$V = \left(P - \frac{P^2}{B + P} \right) \times 27.7, \text{ where}$$

V = suction or vacuum, " w.c.
 P = Absolute atmospheric pressure, psia, at the location where the blower is operated
 B = Rated blower discharge pressure, psig (psig = " w.c. ÷ 27.7)
Example: A blower with a catalog pressure rating of 21" w.c. is used as a suction fan on an installation at 1500 ft altitude. How much suction will it develop?
 P at 1500 ft = 13.9 psia (from table below)
 B = 21 ÷ 27.7 = .76 psig
 $V = \left(13.9 - \frac{(13.9)^2}{.76 + 13.9} \right) \times 27.7 = 20 \text{ "w.c.}$

THE EFFECT OF PRESSURE ON AIR

Basis: 70°F dry air at sea level
(29.92" Hg) barometric pressure

Gauge Pressure, PSIG	Absolute Pressure, PSIA	Density Lb./Cu. Ft.	Specific Gravity	Specific Volume Cu. Ft./Lb.
0	14.7	0.07500	1.000	13.33
1	15.7	0.08010	1.068	12.48
2	16.7	0.08520	1.136	11.74
3	17.7	0.09031	1.204	11.07
4	18.7	0.09541	1.272	10.48
5	19.7	0.10051	1.340	9.95
10	24.7	0.12602	1.680	7.94
15	29.7	0.15153	2.020	6.60
20	34.7	0.17704	2.361	5.65
25	39.7	0.20255	2.701	4.94
30	44.7	0.22806	3.041	4.38
35	49.7	0.25357	3.381	3.94
40	54.7	0.27908	3.721	3.58
45	59.7	0.30459	4.061	3.28
50	64.7	0.33010	4.401	3.03
60	74.7	0.38112	5.082	2.62
70	84.7	0.43214	5.762	2.31
80	94.7	0.48316	6.442	2.07
90	104.7	0.53418	7.122	1.87
100	114.7	0.58520	7.802	1.71
125	139.7	0.71276	9.503	1.40
150	164.7	0.84031	11.204	1.19
175	189.7	0.96786	12.905	1.03
200	214.7	1.09541	14.605	0.91
250	264.7	1.35051	18.007	0.74
300	314.7	1.60561	21.408	0.62
400	414.7	2.11582	28.211	0.47
500	514.7	2.62602	35.014	0.38

THE EFFECT OF ALTITUDE ON AIR

Basis: 70°F dry air at sea level
(29.92" Hg) barometric pressure

Altitude Ft.	Barometric "Hg	Pressure, PSIA	Density Lb./Cu. Ft.	Specific Gravity	Specific Volume Cu. Ft./Lb.
0	29.92	14.7	.07500	1.00	13.33
500	29.38	14.4	.07365	.98	13.58
1000	28.86	14.2	.07234	.96	13.82
1500	28.33	13.9	.07101	.95	14.08
2000	27.82	13.7	.06974	.93	14.34
2500	27.31	13.4	.06846	.91	14.61
3000	26.81	13.2	.06720	.90	14.88
3500	26.32	12.9	.06598	.88	15.16
4000	25.84	12.7	.06477	.86	15.44
4500	25.36	12.5	.06357	.85	15.73
5000	24.89	12.2	.06239	.83	16.03
5500	24.43	12.0	.06124	.82	16.33
6000	23.98	11.8	.06011	.80	16.64
6500	23.53	11.6	.05898	.79	16.95
7000	23.09	11.3	.05788	.77	17.28
7500	22.65	11.1	.05678	.76	17.61
8000	22.22	10.9	.05570	.74	17.95
8500	21.80	10.7	.05465	.73	18.30
9000	21.38	10.5	.05359	.71	18.66
9500	20.98	10.3	.05259	.70	19.01
10000	20.58	10.1	.05159	.69	19.38
15000	16.88	8.29	.04231	.56	23.63
20000	13.75	6.76	.03447	.46	29.01

Helpful conversions:
 Altitude in meters x 3.28 = Altitude in feet
 Barometric pressure in "Hg ÷ 2.036 = Barometric pressure in psia.

THE EFFECT OF TEMPERATURE ON AIR

Basis: 70°F dry air at sea level (29.92" Hg) barometric pressure

Explanation of terms:

$$\text{Absolute Temperature Ratio: } \frac{\text{Temperature, } ^\circ\text{F} + 460}{530}$$

$$\text{Specific Gravity: } \frac{\text{Density at stated temperature}}{.07500}$$

$$\text{Specific Volume: } \frac{1}{\text{Density, lb/cu. ft.}}$$

Temp. °F	Absolute Temp. Ratio	Density Lb./Cu. Ft.	Specific Gravity	Specific Volume Cu. Ft./Lb.	Temp. °F	Absolute Temp. Ratio	Density Lb./Cu. Ft.	Specific Gravity	Specific Volume Cu. Ft./Lb.
-60	.7547	.09938	1.325	10.06	520	1.849	.04056	.541	24.65
-40	.7925	.09464	1.262	10.57	530	1.868	.04015	.535	24.91
-30	.8113	.09244	1.233	10.82	540	1.887	.03975	.530	25.16
-20	.8302	.09034	1.205	11.07	550	1.906	.03936	.525	25.41
-10	.8491	.08833	1.178	11.32	560	1.925	.03897	.520	25.66
0	.8679	.08641	1.152	11.57	570	1.943	.03859	.515	25.91
20	.9057	.08281	1.104	12.08	580	1.962	.03822	.510	26.16
40	1.019	.07361	.981	13.58	590	1.981	.03786	.505	26.42
60	.9811	.07644	1.019	13.08	600	2.000	.03750	.500	26.67
70	1.000	.07500	1.000	13.33	610	2.019	.03715	.495	26.92
80	.9434	.07361	1.060	12.58	620	2.038	.03681	.491	27.17
90	1.038	.07227	.964	13.84	630	2.057	.03647	.486	27.42
100	1.057	.07098	.946	14.09	640	2.075	.03614	.482	27.67
110	1.075	.06974	.930	14.34	650	2.094	.03581	.477	27.92
120	1.094	.06853	.914	14.59	660	2.113	.03549	.473	28.18
130	1.113	.06737	.898	14.84	670	2.132	.03518	.469	28.43
140	1.132	.06624	.883	15.09	680	2.151	.03487	.465	28.68
150	1.151	.06516	.869	15.35	690	2.170	.03457	.461	28.93
160	1.170	.06411	.855	15.60	700	2.189	.03427	.457	29.18
170	1.189	.06310	.841	15.85	710	2.208	.03397	.453	29.43
180	1.208	.06211	.828	16.10	720	2.226	.03369	.449	29.69
190	1.226	.06115	.815	16.35	730	2.245	.03340	.445	29.94
200	1.245	.06023	.803	16.60	740	2.264	.03313	.442	30.19
210	1.264	.05933	.791	16.86	750	2.283	.03285	.438	30.44
220	1.283	.05846	.779	17.11	760	2.302	.03258	.434	30.69
230	1.302	.05761	.768	17.36	770	2.321	.03232	.431	30.94
240	1.321	.05679	.757	17.61	780	2.340	.03206	.427	31.19
250	1.340	.05599	.747	17.86	790	2.358	.03180	.424	31.45
260	1.358	.05521	.736	18.11	800	2.377	.03155	.421	31.70
270	1.377	.05445	.726	18.36	825	2.425	.03093	.412	32.33
280	1.396	.05372	.716	18.62	850	2.472	.03034	.405	32.96
290	1.415	.05300	.707	18.87	875	2.519	.02978	.397	33.58
300	1.434	.05230	.697	19.12	900	2.566	.02923	.390	34.21
310	1.453	.05162	.688	19.37	925	2.613	.02870	.383	34.84
320	1.472	.05096	.679	19.62	950	2.660	.02819	.376	35.47
330	1.491	.05032	.671	19.87	975	2.708	.02770	.369	36.10
340	1.509	.04969	.663	20.13	1000	2.755	.02723	.363	36.73
350	1.528	.04907	.654	20.38	1025	2.802	.02677	.357	37.36
360	1.547	.04848	.646	20.63	1050	2.849	.02623	.350	37.99
370	1.566	.04789	.639	20.88	1100	2.943	.02548	.340	39.25
380	1.585	.04732	.631	21.13	1150	3.033	.02469	.329	40.50
390	1.604	.04676	.623	21.38	1200	3.132	.02395	.319	41.76
400	1.623	.04622	.616	21.64	1250	3.226	.02325	.310	43.02
410	1.642	.04569	.609	21.89	1300	3.321	.02259	.301	44.28
420	1.660	.04517	.602	22.14	1350	3.415	.02196	.293	45.53
430	1.679	.04466	.595	22.39	1400	3.509	.02137	.285	46.79
440	1.698	.04417	.589	22.64	1500	3.698	.02028	.270	49.31
450	1.717	.04368	.582	22.89	1600	3.887	.01930	.257	51.81
460	1.736	.04321	.576	23.14	1700	4.075	.01840	.245	54.35
470	1.755	.04274	.570	23.40	1800	4.264	.01759	.235	56.85
480	1.774	.04229	.564	23.65	1900	4.453	.01684	.225	59.38
490	1.792	.04184	.558	23.90	2000	4.642	.01616	.215	61.88
500	1.811	.04141	.552	24.15	2100	4.830	.01553	.207	64.39
510	1.830	.04098	.546	24.40	2200	5.019	.01494	.199	66.93

CHAPTER 3 – GAS

PHYSICAL PROPERTIES OF COMMERCIAL FUEL GASES

No.	Gas	Constituents – % by Volume									Specific Gravity	Density, Lb per Cu Ft	Specific Volume Cu Ft/Lb
		CH ₄	C ₂ H ₆	C ₃ H ₈	C ₄ H ₁₀	CO	H ₂	CO ₂	O ₂	N ₂			
1	Acetylene	–	–	–	(100% C ₂ H ₂)	–	–	–	–	–	0.91	.07	14.4
2	Blast Furnace Gas	–	–	–	–	27.5	1	11.5	–	60	1.02	.078	12.8
3	Butane (natural gas)	–	–	7	93	–	–	–	–	–	1.95	.149	6.71
4	Butylene (Butene)	–	–	–	(100% C ₄ H ₈)	–	–	–	–	–	1.94	.148	6.74
5	Carbon Monoxide	–	–	–	–	100	–	–	–	–	0.97	.074	13.5
6	Carburetted Water Gas	10.2	(6.1% C ₂ H ₄ , 2.8% C ₆ H ₆)	–	–	34	40.5	3	0.5	2.9	0.63	.048	20.8
7	Coke Oven Gas	32.1	(3.5% C ₂ H ₄ , 0.5% C ₆ H ₆)	–	–	6.3	46.5	2.2	0.8	8.1	0.44	.034	29.7
8	Digester (Sewage) Gas	67	–	–	(8% H ₂ O)	–	–	25	–	–	0.80	.062	16.3
9	Ethane	–	100	–	–	–	–	–	–	–	1.05	.080	12.5
10	Hydrogen	–	–	–	–	–	100	–	–	–	0.07	.0054	186.9
11	Methane	100	–	–	–	–	–	–	–	–	0.55	.042	23.8
12	Natural (Birmingham, AL)	90	5	–	–	–	–	–	–	5	0.60	.046	21.8
13	Natural (Pittsburgh, PA)	83.4	15.8	–	–	–	–	–	–	0.8	0.61	.047	21.4
14	Natural (Los Angeles, CA)	77.5	16.0	–	–	–	–	6.5	–	–	0.70	.054	18.7
15	Natural (Kansas City, MO)	84.1	6.7	–	–	–	–	0.8	–	8.4	0.63	.048	20.8
16	Natural (Groningen, Netherlands)	81.3	2.9	0.4	0.1	–	–	0.9	–	14.4	0.64	.048	20.7
17	Natural (Midlands Grid, U.K.)	91.8	3.5	0.8	0.3	–	–	0.4	–	2.8	0.61	.046	21.8
18	Producer (Wellman-Galusha)	2.3	–	–	–	25	14.5	4.7	–	52.7	0.84	.065	15.4
19	Propane (natural gas)	–	–	100	–	–	–	–	–	–	1.52	.116	8.61
20	Propylene (Propene)	–	–	–	(100% C ₃ H ₆)	–	–	–	–	–	1.45	.111	9.02
21	Sasol (South Africa)	26	–	–	–	22	48	–	0.5	1	0.42	.032	31.3
22	Water Gas (bituminous)	4.6	(0.4% C ₂ H ₄ , 0.3% C ₆ H ₆)	–	–	28.2	32.5	5.5	0.9	27.6	0.71	.054	18.7

COMBUSTION PROPERTIES OF COMMERCIAL FUEL GASES

Air/Gas Ratio, Flammability Limits, Ignition Temperature & Flame Velocity

No.	Gas	Stoichiometric Air/Gas Ratio		Limits of Flammability % Gas in Air/Gas Mixture		Minimum Ignition Temperature in Air, °F	Maximum Flame Velocity in Air, Ft/Sec*
		Cu Ft Air/ Cu Ft Gas	Lb Air/ Lb Gas	Lean	Rich		
1	Acetylene	11.91	13.26	2.5	80	581	9.4
2	Blast Furnace Gas	0.68	0.67	45	72	–	–
3	Butane (natural gas)	30.47	15.63	1.86	8.41	826	2.8
4	Butylene (Butene)	28.59	14.77	1.7	9	829	3.2
5	Carbon Monoxide	2.38	2.46	12	74	1128	2.0
6	Carburetted Water Gas	4.60	7.36	4.2	42.9	–	–
7	Coke Oven Gas	4.99	11.27	4.5	31.5	–	–
8	Digester (Sewage) Gas	6.41	7.97	8	17	–	–
9	Ethane	16.68	15.98	3.15	12.8	882	2.8
10	Hydrogen	2.38	33.79	4	74.2	1065	16.0
11	Methane	9.53	17.23	5	15	1170	2.2
12	Natural (Birmingham, AL)	9.41	15.68	7.03	15.77	–	–
13	Natural (Pittsburgh, PA)	10.58	17.31	4.6	14.7	–	–
14	Natural (Los Angeles, CA)	10.05	14.26	4.9	15.6	–	–
15	Natural (Kansas City, MO)	9.13	14.59	5.4	16.3	–	–
16	Natural (Groningen, Netherlands)	8.41	13.45	6.1	15	1238	1.18
17	Natural (Midlands Grid, U.K.)	9.8	16.13	5	15	1300	0.98
18	Producer (Wellman-Galusha)	1.30	1.56	16.4	69.4	–	–
19	Propane (natural gas)	23.82	15.73	2.37	9.50	898	2.7
20	Propylene (Propene)	21.44	14.77	2	11.1	856	3.3
21	Sasol (South Africa)	4.13	9.84	5.3	37.4	–	–
22	Water Gas (bituminous)	2.01	2.86	8.9	61	–	–

*Uniform flame speed in a 1" diameter tube. Flame speeds increase in larger diameter tubes.

COMBUSTION PROPERTIES OF COMMERCIAL FUEL GASES

Heating Value, Heat Release & Flame Temperature

No.	Gas	Heating Value				Heat release, Btu		Theoretical Flame Temperature °F
		Btu/cu ft		Btu/lb		Per Cu Ft Air	Per Lb Air	
		Gross	Net	Gross	Net			
1	Acetylene	1498	1447	21,569	20,837	125.8	1677	4250
2	Blast Furnace Gas	92	92	1178	1178	135.3	1804	2650
3	Butane (natural gas)	3225	2977	21,640	19,976	105.8	1411	3640
4	Butylene (Butene)	3077	2876	20,780	19,420	107.6	1435	3810
5	Carbon Monoxide	323	323	4368	4368	135.7	1809	3960
6	Carburetted Water Gas	550	508	11,440	10,566	119.6	1595	3725
7	Coke Oven Gas	574	514	17,048	15,266	115.0	1533	3610
8	Digester (Sewage) Gas	690	621	11,316	10,184	107.6	1407	3550
9	Ethane	1783	1630	22,198	20,295	106.9	1425	3710
10	Hydrogen	325	275	61,084	51,628	136.6	1821	3960
11	Methane	1011	910	23,811	21,433	106.1	1415	3640
12	Natural (Birmingham, AL)	1002	904	21,844	19,707	106.5	1420	3565
13	Natural (Pittsburgh, PA)	1129	1021	24,161	21,849	106.7	1423	3562
14	Natural (Los Angeles, CA)	1073	971	20,065	18,158	106.8	1424	3550
15	Natural (Kansas City, MO)	974	879	20,259	18,283	106.7	1423	3535
16	Natural (Groningen, Netherlands)	941	849	19,599	17,678	111.9	1492	3380
17	Natural (Midlands Grid, U.K.)	1035	902	22,500	19,609	105.6	1408	3450
18	Producer (Wellman-Galusha)	167	156	2650	2476	128.5	1713	3200
19	Propane (natural gas)	2572	2365	21,500	19,770	108	1440	3660
20	Propylene (Propene)	2322	2181	20,990	19,630	108.8	1451	3830
21	Sasol (South Africa)	500	443	14,550	13,016	116.3	1551	3452
22	Water Gas (bituminous)	261	239	4881	4469	129.9	1732	3510

COMBUSTION PROPERTIES OF COMMERCIAL FUEL GASES

Combustion Products & %CO₂

No.	Gas	Combustion Products, Cu Ft/Cu Ft Gas				Combustion Products, Lb/Lb Gas				Ultimate CO ₂ %*
		CO ₂	H ₂ O	N ₂	Total	CO ₂	H ₂ O	N ₂	Total	
1	Acetylene	2.00	1.00	9.41	12.41	3.38	0.69	10.19	14.26	17.5
2	Blast Furnace Gas	0.39	0.02	1.14	1.54	.59	—	1.08	1.67	25.5
3	Butane (natural gas)	3.93	4.93	24.07	32.93	3.09	1.59	11.95	16.63	14.0
4	Butylene (Butene)	4.00	4.00	22.59	30.59	3.14	1.29	11.34	15.77	15.0
5	Carbon Monoxide	1.00	—	1.88	2.88	1.57	—	1.89	3.46	34.7
6	Carburetted Water Gas	0.76	0.87	3.66	5.29	1.85	0.87	5.64	8.36	17.2
7	Coke Oven Gas	0.51	1.25	4.02	5.78	1.76	1.76	8.75	12.27	11.2
8	Digester (Sewage) Gas	0.92	1.42	5.44	7.78	1.74	1.10	6.53	9.37	14.5
9	Ethane	2.00	3.00	13.18	18.18	2.93	1.8	12.25	16.98	13.2]
10	Hydrogen	—	1.00	1.88	2.88	—	8.89	25.90	34.79	0
11	Methane	1.00	2.00	7.53	10.53	2.75	2.25	13.23	18.23	11.7
12	Natural (Birmingham, AL)	1.00	2.02	7.48	10.50	2.54	2.11	12.03	16.68	11.8
13	Natural (Pittsburgh, PA)	1.15	2.22	8.37	11.73	2.86	2.27	13.18	18.31	12.1
14	Natural (Los Angeles, CA)	1.16	2.10	7.94	11.20	2.51	1.87	10.88	15.26	12.7
15	Natural (Kansas City, MO)	0.98	1.95	7.30	10.23	2.39	1.95	11.25	15.59	11.9
16	Natural (Groningen, Netherlands)	0.89	1.73	6.74	9.36	2.17	1.73	10.45	14.35	11.7
17	Natural (Midlands Grid, U.K.)	1.05	2.19	7.94	11.78	2.67	2.29	12.84	17.80	11.7
18	Producer (Wellman-Galusha)	0.34	0.17	1.59	2.11	0.61	0.13	1.82	2.56	17.6
19	Propane (natural gas)	3.00	4.17	18.82	25.99	3.00	1.70	12.03	16.73	13.7
20	Propylene (Propene)	3.00	3.00	16.94	22.94	3.14	1.29	11.34	15.77	15.0
21	Sasol (South Africa)	0.48	1.00	3.28	4.76	1.76	1.50	7.63	10.89	12.8
22	Water Gas (bituminous)	0.41	0.47	1.86	2.74	0.89	0.42	2.55	3.86	18.0

*In dry flue gas sample

PROPANE/AIR & BUTANE/AIR MIXTURES

EQUIVALENT BTU TABLES

PROPANE/AIR MIXTURE

Kind of Gas	B.t.u. Content	Specific Gravity	Equivalent Propane-Air Mixture B.t.u.	Specific Gravity
Carbureted Water Gas517	.65	690	1.14
Mixed Water and Coke Oven530	.46	855	1.17
Coke Oven590	.42	1000	1.20
Natural900	.56	1100	1.23
Natural1050	.60	1400	1.28
Natural1140	.65	1560	1.32

BUTANE/AIR MIXTURE

Kind of Gas	B.t.u. Content	Specific Gravity	Equivalent Butane-Air Mixture B.t.u.	Specific Gravity
Carbureted Water Gas517	.65	708	1.20
Mixed Water and Coke Oven530	.46	870	1.25
Coke Oven590	.42	1058	1.31
Natural900	.56	1380	1.41
Natural1050	.60	1550	1.46
Natural1140	.65	1680	1.50

NOTE: The B.t.u. content and specific gravity figures are representative figures and will vary according to area. Therefore, these tables should be used as a guide only.

MIXTURE SPECIFICATIONS

B.t.u. per Cubic Foot of Mixture	PROPANE/AIR MIXTURES				BUTANE/AIR MIXTURES			
	Percentage of Propane by Volume	Percentage of Air by Volume	Percentage of Oxygen by Volume (Orsat)	Specific Gravity of the Mixture	Percentage of Butane by Volume	Percentage of Air by Volume	Percentage of Oxygen by Volume (Orsat)	Specific Gravity of the Mixture
3200	—	—	—	—	100.00	0.00	0.000	1.950
3150	—	—	—	—	98.44	1.56	0.328	1.935
3100	—	—	—	—	96.88	3.12	0.656	1.920
3050	—	—	—	—	95.32	4.68	0.984	1.905
3000	—	—	—	—	93.75	6.25	1.312	1.891
2950	—	—	—	—	92.20	7.80	1.643	1.875
2900	—	—	—	—	90.62	9.38	1.967	1.861
2850	—	—	—	—	89.08	10.92	2.297	1.846
2800	—	—	—	—	87.51	12.49	2.625	1.831
2750	—	—	—	—	85.95	14.05	2.953	1.817
2700	—	—	—	—	84.38	15.62	3.280	1.802
2650	—	—	—	—	82.82	17.18	3.612	1.786
2600	—	—	—	—	81.25	18.75	3.935	1.771
2550	100.00	0.00	0.000	1.523	79.70	20.30	4.268	1.755
2500	98.04	1.96	0.409	1.513	78.18	21.82	4.590	1.744
2450	96.08	3.92	0.819	1.502	76.58	23.42	4.921	1.728
2400	94.12	5.88	1.288	1.492	75.00	25.00	5.249	1.712
2350	92.16	7.84	1.639	1.482	73.44	26.56	5.576	1.698
2300	90.19	9.81	2.050	1.472	71.86	28.14	5.899	1.683
2250	88.24	11.76	2.458	1.461	70.30	29.70	6.238	1.668
2200	86.27	13.73	2.869	1.451	68.79	31.21	6.561	1.653
2150	84.31	15.69	3.279	1.441	67.20	32.80	6.889	1.638
2100	82.35	17.65	3.688	1.431	65.63	34.37	7.219	1.623
2050	80.39	19.61	4.098	1.420	64.09	35.91	7.548	1.608
2000	78.43	21.56	4.506	1.410	62.52	37.48	7.869	1.593
1950	76.47	23.53	4.918	1.400	60.96	39.04	8.200	1.579
1900	74.51	25.49	5.317	1.390	59.38	40.62	8.542	1.564
1850	72.55	27.45	5.737	1.379	57.87	42.13	8.868	1.550
1800	70.58	29.42	6.149	1.369	56.25	43.75	9.162	1.535
1750	68.62	31.38	6.558	1.359	54.69	45.31	9.500	1.520
1700	66.67	33.33	6.964	1.349	53.17	46.83	9.850	1.505
1650	64.70	35.30	7.378	1.338	51.60	48.40	10.180	1.490
1600	62.74	37.26	7.787	1.328	50.00	50.00	10.488	1.475
1550	60.78	39.22	8.197	1.318	48.50	51.50	10.817	1.461
1500	58.82	41.18	8.606	1.308	46.92	53.08	11.130	1.446
1450	56.86	43.14	9.016	1.297	45.35	54.65	11.490	1.431
1400	54.90	45.10	9.246	1.287	43.75	56.25	11.810	1.416
1350	52.94	47.06	9.835	1.277	42.22	57.78	12.130	1.401
1300	50.98	49.02	10.245	1.267	40.60	59.40	12.481	1.386
1250	49.02	50.98	10.654	1.256	39.09	60.91	12.795	1.371
1200	47.06	52.94	11.064	1.246	37.50	62.50	13.137	1.356
1150	45.09	54.91	11.476	1.236	35.92	64.08	13.462	1.340
1100	43.13	56.87	11.886	1.226	34.38	65.62	13.787	1.326
1050	41.17	58.83	12.295	1.215	32.80	67.21	14.100	1.312
1000	39.21	60.79	12.705	1.205	31.25	68.75	14.412	1.296
950	37.25	62.75	13.115	1.195	29.75	70.25	14.775	1.282
900	35.29	64.71	13.524	1.185	28.20	71.80	15.100	1.266
850	33.33	66.67	13.934	1.174	26.55	73.45	15.425	1.252
800	31.37	68.63	14.344	1.164	25.00	75.00	15.712	1.237
750	29.41	70.59	14.753	1.154	23.50	76.50	16.081	1.223
700	27.45	72.55	15.163	1.144	21.88	78.12	16.400	1.206
650	25.49	74.51	15.573	1.133	20.38	79.62	16.750	1.194
600	23.53	76.47	15.982	1.123	18.75	81.25	17.081	1.178
550	21.56	78.44	16.394	1.113	17.25	82.75	17.412	1.163
500	19.61	80.39	16.892	1.103	15.63	84.37	17.712	1.148
450	17.65	82.35	17.211	1.092	14.13	85.87	18.081	1.135
400	15.69	84.31	17.621	1.082	12.50	87.50	18.375	1.120
350	13.73	86.27	18.031	1.072	11.00	89.00	18.687	1.105
300	11.76	88.24	18.442	1.062	9.38	90.62	19.031	1.089
250	9.80	90.20	18.852	1.051	7.75	92.25	19.313	1.074
200	7.84	92.16	19.261	1.041	6.25	93.75	19.687	1.059
150	5.88	94.12	19.670	1.031	4.75	95.25	20.000	1.045
100	3.92	96.08	20.081	1.021	3.13	96.87	20.342	1.029

CHAPTER 4 – OIL

FUEL OIL SPECIFICATIONS PER ANSI/ASTM D 396-79^A

Grade of Fuel Oil	Flash Point, °C		Pour Point, °C		Water and Sediment, vol %		Carbon Residue on 10% Bottoms, %		Ash, %	Distillation Temperatures, °C(°F)			Saybolt Viscosity, s ^D				Kinematic Viscosity, cSt ^D						Specific Gravity 60/60°F (deg API) Max	Copper Strip Corrosion 30 min Max	Sulfur, % Max
	Min	Max	Min	Max	Max	Max	10% Point Max	90% Point Min		Point Max	Universal at 38°C(100°F)		Furoil at 50°C(122°F)		At 38°C(100°F)		At 40°C(104°F)		At 50°C(122°F)						
No. 1 A distillate oil intended for vaporizing pot-type burners and other burners requiring this grade of fuel	38	-18 ^C	(100)	(0)	0.05	0.15	—	—	—	215 (420)	—	288 (550)	—	—	—	—	1.4	2.2	1.3	2.1	—	—	0.8499 (35 min)	No. 3	0.5
No. 2 A distillate oil for general purpose heating for use in burners not requiring No. 1 fuel oil	38	-6 ^C	(100)	(20)	0.05	0.35	—	—	—	—	282 ^C (540)	338 (640)	(32.6)	(37.9)	—	—	2.0 ^C	3.6	1.9 ^C	3.4	—	—	0.8762 (30 min)	No. 3	0.5 ^B
No. 4 Preheating usually required for handling or burning	55	-6 ^C	(130)	(20)	0.50	—	0.10	—	—	—	—	—	(45)	(125)	—	—	5.8	26.4 ^F	5.5	24.0 ^F	—	—	—	—	—
No. 5 (Light) Preheating may be required depending on climate and equipment	55	—	(130)	—	1.00	—	0.10	—	—	—	—	—	(>125)	(300)	—	—	>26.4	65 ^F	>24.0	58 ^F	—	—	—	—	—
No. 5 (Heavy) Preheating may be required for burning and, in cold climates, may be required for handling	55	—	(130)	—	1.00	—	0.10	—	—	—	—	—	(>300)	(900)	(23)	(40)	>65	194 ^F	>58	168 ^F	(42)	(81)	—	—	—
No. 6 Preheating required for burning and handling	60	^G	(140)	—	2.00 ^E	—	—	—	—	—	—	—	(>900)	(9000)	(>45)	(300)	—	—	—	—	>92	638 ^F	—	—	—

^A It is the intent of these classifications that failure to meet any requirement of a given grade does not automatically place an oil in the next lower grade unless in fact it meets all requirements of the lower grade.

^B In countries outside the United States other sulfur limits may apply.

^C Lower or higher pour points may be specified whenever required by conditions of storage or use. When pour point less than -18°C (0°F) is specified, the minimum viscosity for grade No. 2 shall be 1.7 cSt (31.5 SUS) and the minimum 90% point shall be waived.

^D Viscosity values in parentheses are for information only and not necessarily limiting.

^E The amount of water by distillation plus the sediment by extraction shall not exceed 2.00%. The amount of sediment by extraction shall not exceed 0.50%. A deduction in quantity shall be made for all water and sediment in excess of 1.0%.

^F Where low sulfur fuel oil is required, fuel oil failing in the viscosity range of a lower numbered grade down to and including No. 4 may be supplied by agreement between purchaser and supplier. The viscosity range of the initial shipment shall be identified and advance notice shall be required when changing from one viscosity range to another. This notice shall be in sufficient time to permit the user to make the necessary adjustments.

^G Where low sulfur fuel oil is required. Grade 6 fuel oil will be classified as low pour + 15°C (60°F) max or high pour (no max). Low pour fuel oil should be used unless all tanks and lines are heated.

© COPYRIGHT ASTM • REPRINTED WITH PERMISSION

TYPICAL PROPERTIES OF COMMERCIAL FUEL OILS IN THE U.S.

Grade of Fuel Oil	Flash Point, °F	Pour Point, °F	Water, Vol. %	Carbon Residue, Wt. %	Ash, Wt. %
1	106 to 174	-85 to -10	0.050 max.	0.200 max.	—
2	120 to 250	-60 to +35	0.060 max.	0.820 max.	—
4*	150 to 276	-40 to +80	0.3 max.	0.19 to 7.6	0.07 max.
5 (Light)*	154 to 250	-15 to +55	0.08 to 0.6	2.10 to 13.6	0.001 to 0.08
5 (Heavy)*	136 to 300+	-17 to +90	0.4 max.	1.55 to 9.6	0.001 to 0.16
6	140 to 250	0 to +110	0.300 max.	1.02 to 15.80	0.001 to 0.630

Grade of Fuel Oil	Viscosity, SSU @ 100°F	Specific Gravity 60/60°F	Gravity, °API	Sulfur, Wt %	Gross Heating Value, Btu/gallon
1	37 max.	0.79 to 0.85	47.9 to 34.8	0 to 0.47	131,100 to 138,700
2	42 max.	0.80 to 0.92	45.3 to 21.9	0.04 to 0.5	132,600 to 147,400
4*	35 to 160	0.85 to 0.99	34.6 to 12.1	0.18 to 1.81	140,400 to 151,700
5 (Light)*	80 to 700	0.89 to 1.01	28.2 to 8.5	0.58 to 3.48	142,700 to 156,400
5 (Heavy)*	240 to 1300	0.91 to 1.02	23.4 to 7.5	0.6 to 2.54	144,800 to 153,600
6	240 to 6100	0.92 to 1.09	22.0 to -1.5	0.17 to 3.52	146,700 to 162,000

The above data are summarized from *Heating Oils, 1984*, published by the American Petroleum Institute and U.S. Dept. of Energy. The ranges in the tables represent the extreme maximums and minimums for the oil samples included in the survey.

*1975-1976 data. No data available for these grades in 1983-1984.

FUEL OIL VISCOSITY CONVERSIONS

This chart converts four commonly-used fuel oil viscosity scales to a common base of centistokes

ABBREVIATIONS: SSU = Saybolt Seconds Universal
 SSF = Saybolt Seconds Furol
 SRI = Seconds Redwood #1
 °E = Degrees Engler

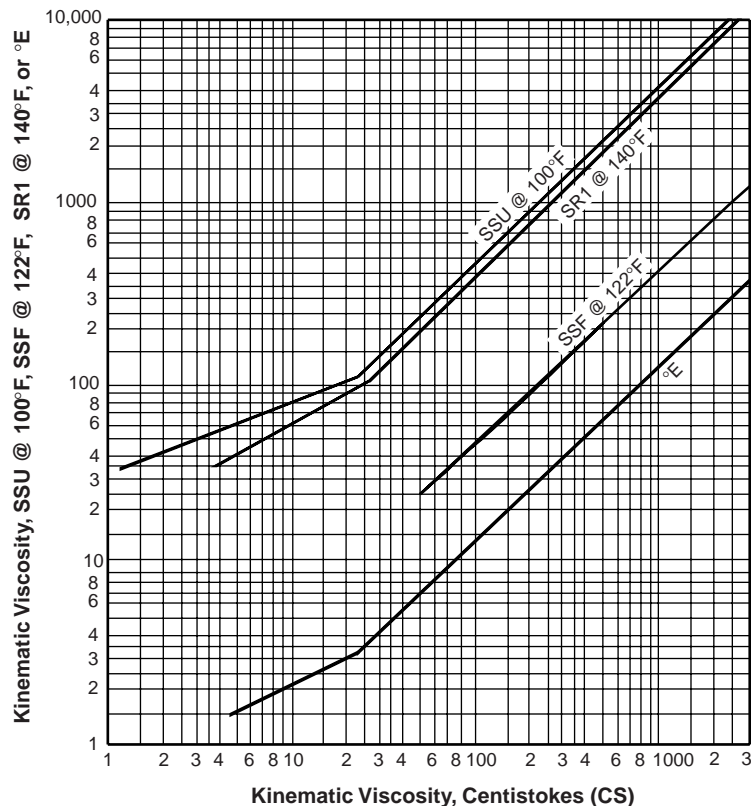

° API VS. OIL SPECIFIC GRAVITY & GROSS HEATING VALUE

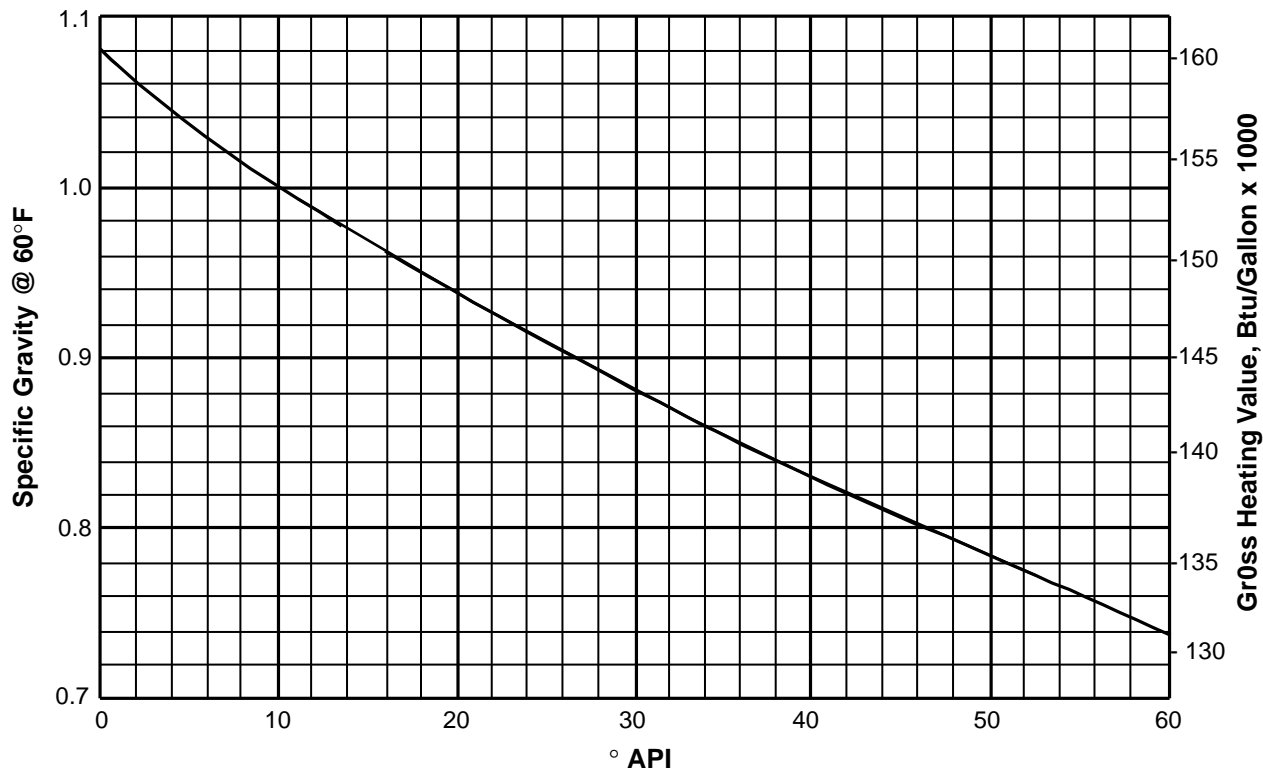

To determine specific gravity of an oil, find °API at the bottom of the graph, read up to the curve, and left to the specific gravity.

To find gross heating value of an oil, find °API at the bottom of the graph, read up to the curve, and right to the heating value.

For greater accuracy or for gravities not on this chart, use these equations:

$$\text{Specific gravity @ } 60/60^{\circ}\text{F} = \frac{141.5}{^{\circ}\text{API} + 131.5}$$

$$\begin{aligned} \text{Gross Heating Value, Btu/lb} \\ &= 17,887 + (57.5 \times ^{\circ}\text{API}) - (102.2 \times \%S) \end{aligned}$$

where %S is weight % sulfur in the oil.

$$\begin{aligned} \text{Gross Heating Value, Btu/gal} \\ &= \text{g.h.v., Btu/lb} \times 8.335 \times \text{specific gravity} \end{aligned}$$

OIL PIPING PRESSURE LOSSES

These charts show oil pressure drop per 100 equivalent feet of horizontal schedule 40 steel pipe. To determine total equivalent length, add equivalent lengths of fittings and valves (Page 16) to the actual linear feet of pipe.

The charts for 1000 SSU and 10,000 SSU oils are accompanied by correction factors for oils of other viscosities. To find the pressure drop for an oil not on either of these charts, simply multiply the drop from the chart by the appropriate correction factor.

If the entrance and exit ends of the oil line are at different elevations, the static head of the oil must be added to or subtracted from the calculated piping drop.

Static head, psi = 0.433 x specific gravity of oil x elevation difference, ft.

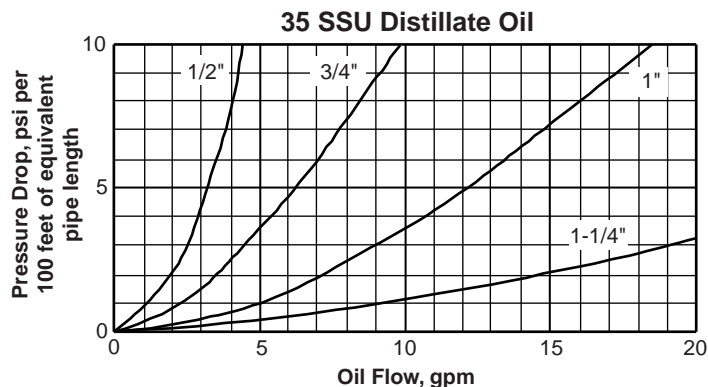

OIL PIPING PRESSURE LOSSES (Cont'd)

100 SSU Intermediate Oil

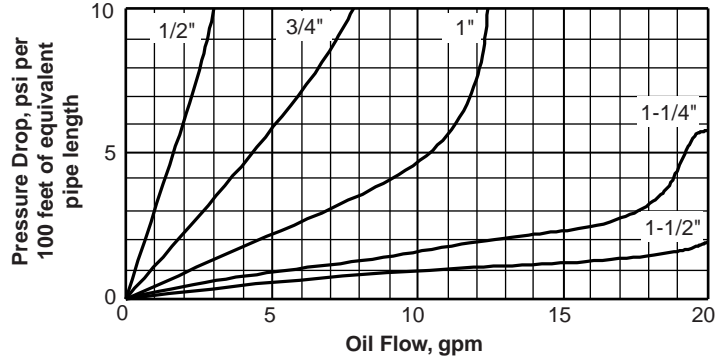

1000 SSU Heavy Oil

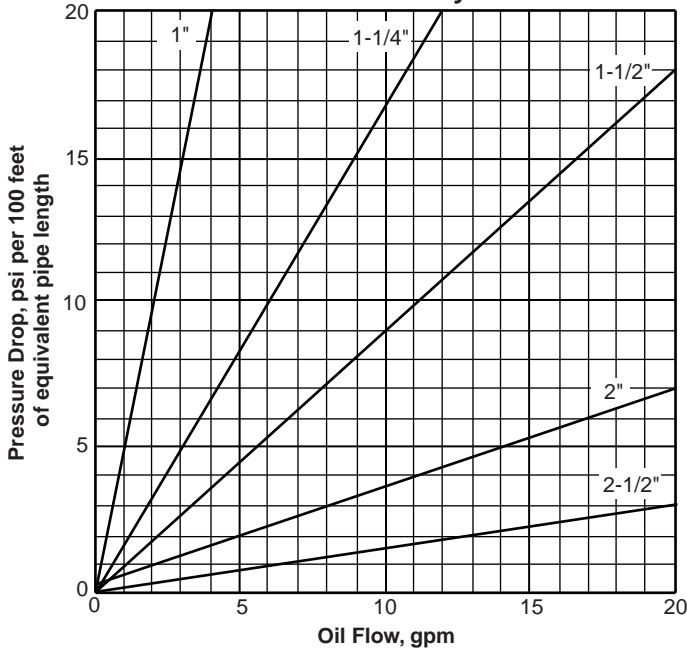

Pressure Drop
Correction Factors
for Other Viscosities

Viscosity, SSU	Correction Factor
200	0.2
300	0.3
400	0.4
500	0.5
600	0.6
700	0.7
800	0.8
900	0.9
1200	1.2
1500	1.5
2000	2.0
2500	2.5

10,000 SSU Heavy Oil

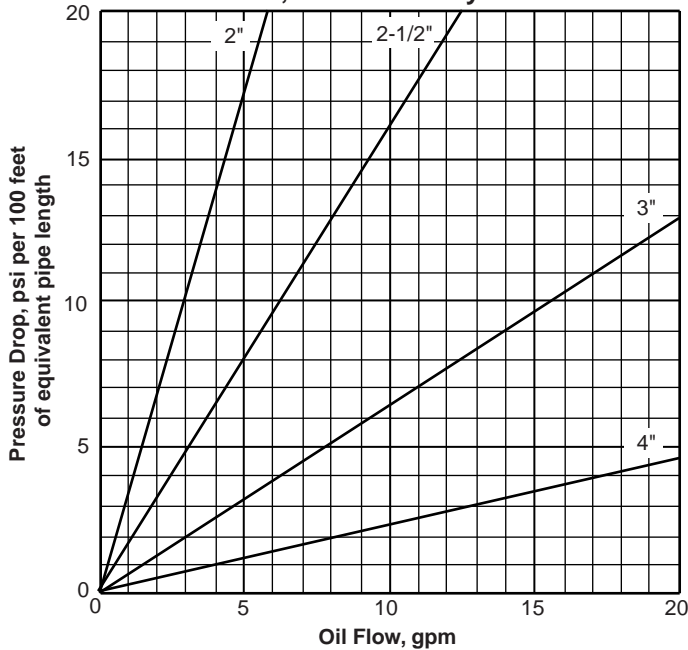

Pressure Drop
Correction Factors
for Other Viscosities

Viscosity, SSU	Correction Factor
2000	0.2
3000	0.3
4000	0.4
5000	0.5
6000	0.6
7000	0.7
8000	0.8
9000	0.9
12000	1.2
15000	1.5

OIL PIPING TEMPERATURE LOSSES

This table lists the temperature drop of 220°F oil flowing through steel pipe insulated with 1" thick 85% magnesia pipe insulation. Ambient temperature is assumed to be 60°F. For oil temperatures other than 220°F, multiply the temperature loss by the appropriate correction factor.

OIL TEMPERATURE DROP IN °F PER FOOT OF PIPE

Oil Flow GPH	Nominal Pipe Size									
	1/4	3/8	1/2	3/4	1	1-1/4	1-1/2	2	2-1/2	3
.5	10.92	12.18	13.68	15.48	17.64	20.6	22.50	26.30	30.00	34.8
1	5.46	6.09	6.84	7.74	8.82	10.3	11.25	13.15	15.00	17.4
2	2.73	3.04	3.42	3.87	4.41	5.15	5.63	6.57	7.50	8.70
3	1.82	2.03	2.28	2.58	2.94	3.43	3.75	4.38	5.00	5.75
4	1.365	1.52	1.71	1.933	2.205	2.58	2.82	3.28	3.75	4.35
5	1.09	1.218	1.368	1.548	1.764	2.06	2.25	2.63	3.00	3.48
10	.546	.609	.684	.774	.882	1.03	1.125	1.315	1.50	1.74
15	.364	.405	.455	.515	.588	.686	.750	.876	1.00	1.16
20	.273	.304	.342	.387	.441	.515	.563	.657	.750	.870
30	.182	.203	.228	.258	.294	.343	.375	.438	.500	.575
40	.136	.152	.171	.193	.220	.258	.282	.328	.375	.435
60	.091	.101	.114	.129	.147	.172	.187	.219	.250	.290
80	.068	.076	.086	.097	.110	.129	.141	.164	.188	.218
100	.055	.061	.068	.077	.088	.103	.113	.132	.150	.174
200	.027	.030	.034	.039	.044	.052	.056	.066	.075	.087
300	.018	.020	.023	.026	.029	.034	.038	.044	.050	.058

OIL TEMPERATURE CORRECTION FACTORS

Oil Temperature, °F	Factor	Oil Temperature, °F	Factor
130	0.44	190	0.81
140	0.5	200	0.88
150	0.56	210	0.94
160	0.63	230	1.06
170	0.69	240	1.13
180	0.75	250	1.19

Temperature losses from uninsulated pipe will vary with the pipe size. For 1/4" pipe, the losses are about 8 times the figures in the table. For 3" pipe, they are about 6 times the table values.

CHAPTER 5 – STEAM & WATER

BOILER TERMINOLOGY AND CONVERSION FACTORS

Boiler horsepower – One boiler horsepower
 = 33,479 Btu/hr heat to steam
 = 34.5 lb/hr of water evaporated
 from and at 212°F
 = 9.8 Kilowatts

Dry Steam – Steam which contains no liquid water.

Enthalpy – Heat content, Btu/lb, of a liquid or vapor.

Latent heat of vaporization – The heat required to convert a material from its liquid to its vapor phase without raising its temperature. The latent heat of vaporization of water at 1 atmosphere pressure and 212°F is 970.3 Btu/lb.

Quality – In a mixture of steam and water, the weight percentage which is present as steam; in other words, the percent of complete vaporization which has taken place. The quality of saturated steam is 100%.

Saturated Steam – Steam which is at the same temperature as the water from which it was evaporated.

Wet Steam – Steam which contains liquid water. Its quality is less than 100%.

PROPERTIES OF SATURATED STEAM

Temperature, °F	Pressure, psi		V _g , Specific Volume of Vapor cu ft/lb	h _f , Heat Content of Liquid, Btu/lb	h _{fg} , Latent Heat, of Vaporization, Btu/lb	h _g , Heat Content of Vapor Btu/lb
	Absolute	Gauge				
32	.089	–	3304.7	-0.018	1075.5	1075.5
40	.121	–	2445.8	8.03	1071.0	1079.0
50	.178	–	1704.8	18.05	1065.3	1083.4
60	.256	–	1207.6	28.06	1059.7	1087.7
70	.363	–	868.4	38.05	1054.0	1092.1
80	.507	–	633.3	48.04	1048.4	1096.4
90	.698	–	468.1	58.02	1042.7	1100.8
100	.949	–	350.4	68.00	1037.1	1105.1
110	1.28	–	265.4	77.98	1031.4	1109.3
120	1.69	–	203.3	87.97	1025.6	1113.6
130	2.22	–	157.3	97.96	1019.8	1117.8
140	2.89	–	123.0	107.95	1014.0	1122.0
150	3.72	–	97.07	117.95	1008.2	1126.1
160	4.74	–	77.29	127.96	1002.2	1130.2
170	5.99	–	62.06	137.97	996.2	1134.2
180	7.51	–	50.22	148.00	990.2	1138.2
190	9.34	–	40.96	158.04	984.1	1142.1
200	11.53	–	33.64	168.09	977.9	1146.0
212	14.696	0	26.80	180.17	970.3	1150.5
220	17.19	2.49	23.15	188.23	965.2	1153.4
240	24.97	10.27	16.32	208.45	952.1	1160.6
260	35.43	20.73	11.76	228.76	938.6	1167.4
280	49.20	34.50	8.64	249.17	924.6	1173.8
300	67.01	52.31	6.47	269.7	910.0	1179.7
320	89.64	74.94	4.91	290.4	894.8	1185.2
340	117.99	103.29	3.79	311.3	878.8	1190.1
360	153.01	138.31	2.96	332.3	862.1	1194.4
380	195.73	181.03	2.34	353.6	844.5	1198.0
400	247.26	232.56	1.86	375.1	825.9	1201.0
500	680.86	666.16	0.67	487.9	714.3	1202.2
600	1543.2	1528.5	0.27	617.1	550.6	1167.7
700	3094.3	3079.6	0.075	822.4	172.7	995.2
705.47*	3208.2	3193.5	0.051	906.0	0	906.0

*Critical Temperature

BTU/HR REQUIRED TO GENERATE ONE BOILER H.P.

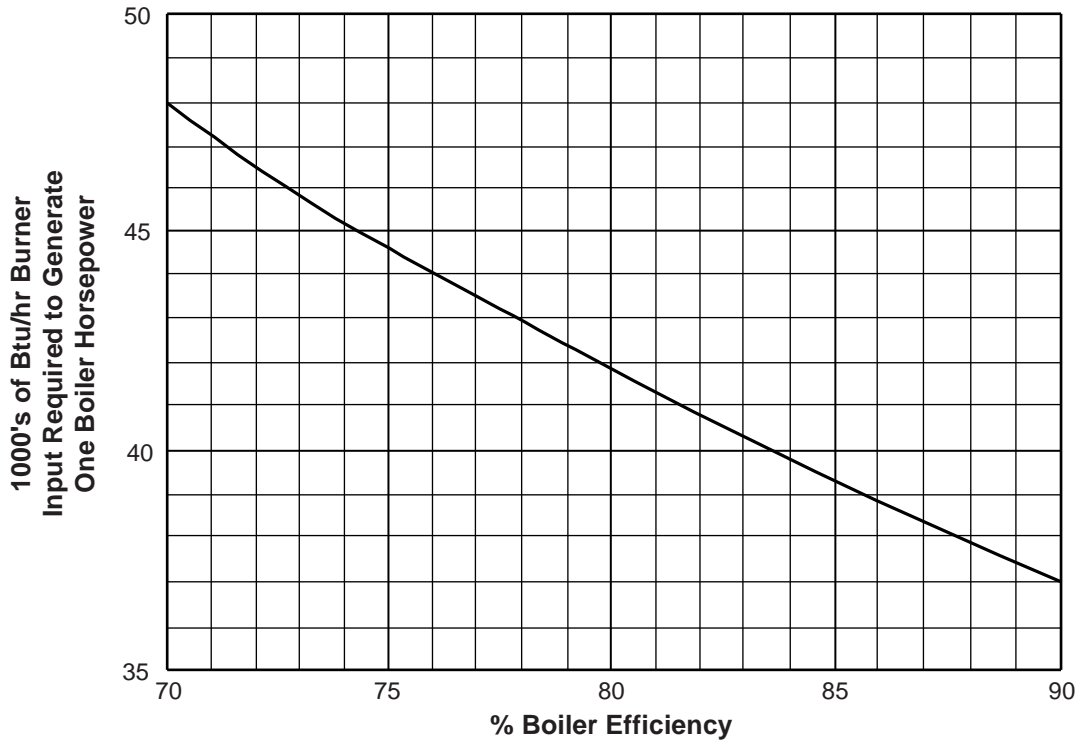

SIZING WATER PIPING

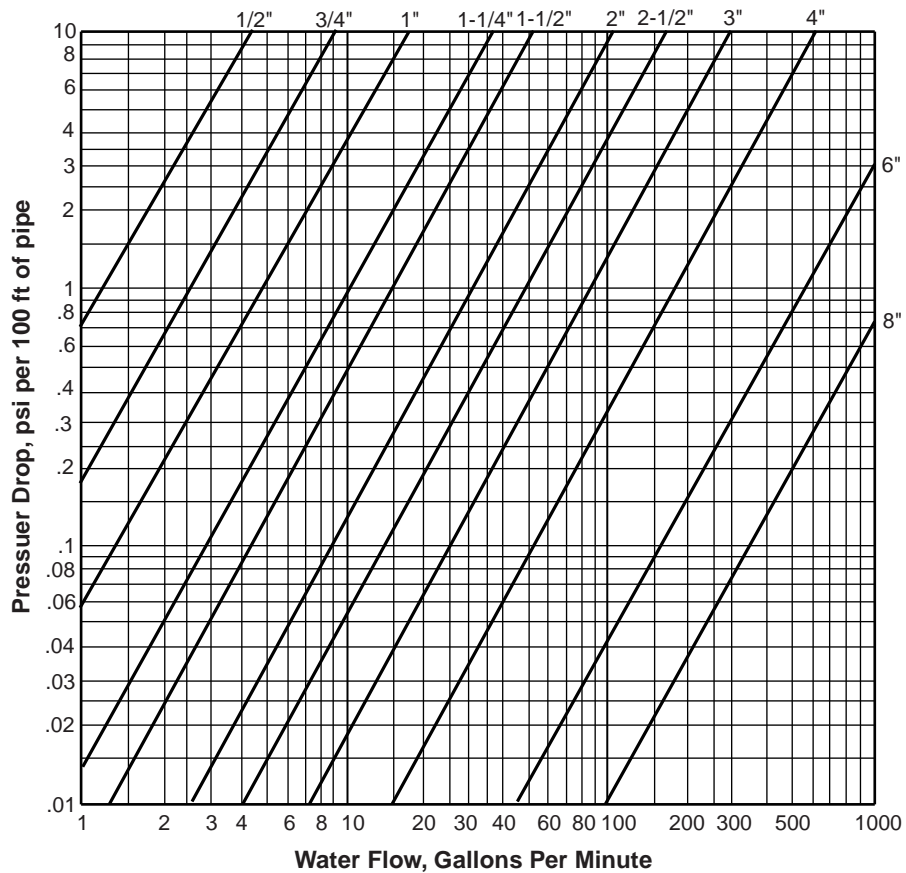

Pressure drops are for 60°F water flowing in horizontal Schedule 40 steel pipe.

SIZING STEAM PIPING

Pipe Size, Inches (Schedule 40)	Lb/hr steam for piping pressure drop of 1 psi/100ft						Lb/hr steam for piping drop of 5 psi/100 ft				
	Steam Pressure, psig						Steam Pressure, psig				
	5	10	25	50	100	150	10	25	50	100	150
3/4	31	34	43	53	70	84	73	93	120	155	185
1	61	68	86	110	140	170	145	185	235	315	375
1-1/4	135	150	190	235	310	370	320	410	520	690	820
1-1/2	210	230	290	370	485	570	500	640	810	1,050	1,300
2	425	470	590	750	980	1,150	1,000	1,300	1,650	2,150	2,600
2-1/2	700	780	980	1,250	1,600	1,900	1,650	2,150	2,700	3,600	4,250
3	1,280	1,450	1,800	2,250	2,950	3,500	3,050	3,900	4,300	6,600	7,800
4	2,700	3,000	3,800	4,750	6,200	7,400	6,500	8,200	10,500	14,000	16,500
6	8,200	9,200	11,500	14,500	19,000	22,500	19,500	25,000	31,500	42,000	50,000
8	17,000	19,000	24,000	30,000	39,500	47,000	41,000	52,000	66,000	88,000	105,000

These flows were calculated from Babcock's Equation,

$$W = 87 \sqrt{\frac{Pd D^5}{(1 + \frac{3.6}{D}) L}}$$

where W = steam flow, lb/minute
P = pressure drop, psi
D = inside diameter of pipe, inches
d = density of steam, lb/cu ft
L = length of pipe run, feet

CHAPTER 6 – ELECTRICAL DATA

ELECTRICAL FORMULAS

Ohm's Law	Motor Formulas	D.C. Circuit Power Formulas
Amperes = Volts/Ohms	Torque (lb-ft) = $\frac{5250 \times \text{Horsepower}}{\text{rpm}}$	Watts = Volts x Amperes
Ohms = Volts/Amperes	Synchronous rpm = $\frac{\text{Hertz} \times 120}{\text{Poles}}$	Amperes = Watts/Volts
Volts = Amperes x Ohms		Volts = Watts/Amperes
		Horsepower = $\frac{\text{Volts} \times \text{Amperes} \times \text{Efficiency}^*}{746}$
A.C. Circuit Power Formulas		
Single-Phase		
Watts	= Volts x Amps x Power Factor*	= 1.73 x Volts x Amps x Power Factor*
Amperes	= $\frac{\text{Watts}}{\text{Volts} \times \text{Power Factor}^*}$	= $\frac{\text{Watts}}{1.73 \times \text{Volts} \times \text{Power Factor}^*}$
	= $\frac{\text{kVA} \times 1000}{\text{Volts}}$	= $\frac{\text{kVA} \times 1000}{1.73 \times \text{Volts}}$
	= $\frac{\text{Horsepower} \times 746}{\text{Volts} \times \text{Efficiency}^* \times \text{Power Factor}^*}$	= $\frac{\text{Horsepower} \times 746}{1.73 \times \text{Volts} \times \text{Effic.}^* \times \text{Power Factor}^*}$
Kilowatts	= $\frac{\text{Amps} \times \text{Volts} \times \text{Power Factor}^*}{1000}$	= $\frac{1.73 \times \text{Amps} \times \text{Volts} \times \text{Power Factor}^*}{1000}$
kVA	= $\frac{\text{Amps} \times \text{Volts}}{1000}$	= $\frac{1.73 \times \text{Amps} \times \text{Volts}}{1000}$
Horsepower	= $\frac{\text{Volts} \times \text{Amps} \times \text{Effic.}^* \times \text{Pwr. Factor}^*}{746}$	= $\frac{1.73 \times \text{Volts} \times \text{Amps} \times \text{Effic.}^* \times \text{Pwr. Fact.}^*}{746}$

*Expressed as a decimal

ELECTRICAL WIRE – DIMENSIONS & RATINGS

All data for solid copper wire

A.W.G. Wire Gauge	Diameter, Inches	Resistance, Ohms per 1000 Ft @ 77°F	Maximum Allowable Current Capacity per NFPA 70-1984*, Amps
0	.3249	.100	125-170
1	.2893	.126	110-150
2	.2576	.159	95-130
3	.2294	.201	85-110
4	.2043	.253	70-95
6	.1620	.403	55-75
8	.1285	.641	40-55
10	.1019	1.02	30-40
12	.0808	1.62	20-30
14	.0641	2.58	15-25
16	.0508	4.09	18
18	.0403	6.51	14

*Maximum current capacity permitted by National Electrical Code, NFPA 70-1984, varies with type of insulation, ambient temperature, voltage carried, and other factors. Consult NFPA 70-1984 for specific information.

NEMA SIZE STARTERS FOR MOTORS

Horsepower	Starter size for				
	115/1/60	230/1/60	230/3/60	380/3/60	460/3/60 575/3/60
Up to 1/3	00	00	00	00	00
1/2 to 1	0	00	00	00	00
1-1/2	1	1	00	00	00
2	1	1	0	0	00
3	2	2	0	0	0
5	3	2	1	0	0
7-1/2	3	2	1	1	1
10	–	3	2	1	1
15	–	–	2	2	2
20-25	–	–	3	2	2
30	–	–	3	3	3
40-50	–	–	4	3	3
60-75	–	–	5	4	4
100	–	–	5	5	4
125-150	–	–	6	5	5
200	–	–	6	6	5

All sizes listed apply only to magnetic starters with fusible alloy overload relays.

NEMA ENCLOSURES

NEMA 1. General Purpose – Indoor

Sheet metal enclosures intended for indoor use. Primary purpose is to prevent accidental personnel contact with enclosed equipment, although they will also provide some protection against falling dirt.

NEMA 2. Drip Proof – Indoor

Indoor enclosure that protects contents against falling noncorrosive liquids and dirt. Must be equipped with a drain.

NEMA 3. Dust Tight, Raintight & Sleet-Resistant (Ice-Resistant),

NEMA 3R. Rainproof & Sleet-Resistant (Ice-Resistant).

NEMA 3S. Dust Tight, Raintight & Sleet-Proof (Ice-Proof)

Outdoor enclosures for protection against windblown dust, rain and sleet. All have provision for locking.

NEMA 4. Water Tight & Dust Tight – Indoor & Outdoor

Protect contents against splashing, seeping, falling, or hose-directed water and severe external condensation. Commonly used in food-processing plants where equipment hosedown is required.

NEMA 6. Submersible, Watertight, Dust Tight and Sleet (Ice)-Resistant–Indoor & Outdoor

Capable of being submerged up to 30 minutes in up to 6 feet of water without harm to the contents.

NEMA 7. Hazardous Locations – Indoor – Air Break Equipment

Enclosures for use in atmospheres containing explosive gases and vapors as defined in Class I, Division I, Groups A, B, C or D of the National Electrical Code. Enclosure must contain an internal explosion without causing an external hazard. Construction details vary with the nature of the explosive gas or vapor.

NEMA 8. Hazardous Locations – Indoor – Oil-Immersed Equipment

Enclosures for oil-immersed circuit breakers in Class I, Division I, Group A, B, C or D hazardous atmospheres.

NEMA 9. Hazardous Locations – Indoor – Air-Break Equipment

Used in Class II, Division I, Group E, F, or G hazardous locations as defined by the National Electrical Code. Enclosures are designed to exclude combustible or explosive dusts.

NEMA 10. Mine Atmospheres

For use in mines containing methane or natural gas.

NEMA 11. Corrosion-Resistant and Drip Proof – Indoor

Indoor enclosures that protect contents from dripping, seepage and external condensation of corrosive liquids, as well as corrosive fumes.

NEMA 12. Industrial Use – Dust Tight & Drip Tight – Indoor

Protect enclosed equipment from lint, fibers, flyings, dust, dirt and light splashing, seepage, dripping and external condensation of noncorrosive liquids.

NEMA 13. Oil Tight & Dust Tight – Indoor

Protect enclosed equipment from lint, dust and seepage, external condensation and spraying of water, oil, or coolant. They have oil-resistant gaskets and must have provision for oiltight conduit entry.

For more complete details on application and construction specifications for NEMA Enclosures, refer to NEMA Standards Publication No. ICS 6.

ELECTRIC MOTORS— FULL LOAD CURRENT, AMPERES

Horse Power	Single Phase AC Motors		Three-Phase AC Motors Induction Type – Squirrel Cage & Wound-Rotor			
	115V	230V	115V	230V	460V	575V
	1/6	4.4	2.2	—	—	—
1/4	5.8	2.9	—	—	—	—
1/3	7.2	3.6	—	—	—	—
1/2	9.8	4.9	4	2	1	.8
3/4	13.8	6.9	5.6	2.8	1.4	1.1
1	16	8	7.2	3.6	1.8	1.4
1-1/2	20	10	10.4	5.2	2.6	2.1
2	24	12	13.6	6.8	3.4	2.7
3	34	17	—	9.6	4.8	3.9
5	56	28	—	15.2	7.6	6.1
7-1/2	80	40	—	22	11	9
10	100	50	—	28	14	11
15	—	—	—	42	21	17
20	—	—	—	54	27	22
25	—	—	—	68	34	27
30	—	—	—	80	40	32
40	—	—	—	104	52	41
50	—	—	—	130	65	52
60	—	—	—	154	77	62
75	—	—	—	192	96	77
100	—	—	—	248	124	99
125	—	—	—	312	156	125
150	—	—	—	360	180	144
200	—	—	—	480	240	192

CHAPTER 7 – PROCESS HEATING

HEAT BALANCES—DETERMINING THE HEAT NEEDS OF FURNACES AND OVENS

Although rules of thumb are frequently used to size furnace and oven burners, they have to be used with care. All rules of thumb are based on certain assumptions about production rates, furnace dimensions, and insulation. If the system under consideration differs from these assumed conditions, using a rule of thumb can result in a significant error.

For out-of-the ordinary conditions, or where more accurate results are required, heat balance calculations are preferred. A heat balance consists of calculating load heat requirements and adding losses to them to determine the heat input.

Below is a schematic representation of the heat balance in a fuel-fired heat processing device.

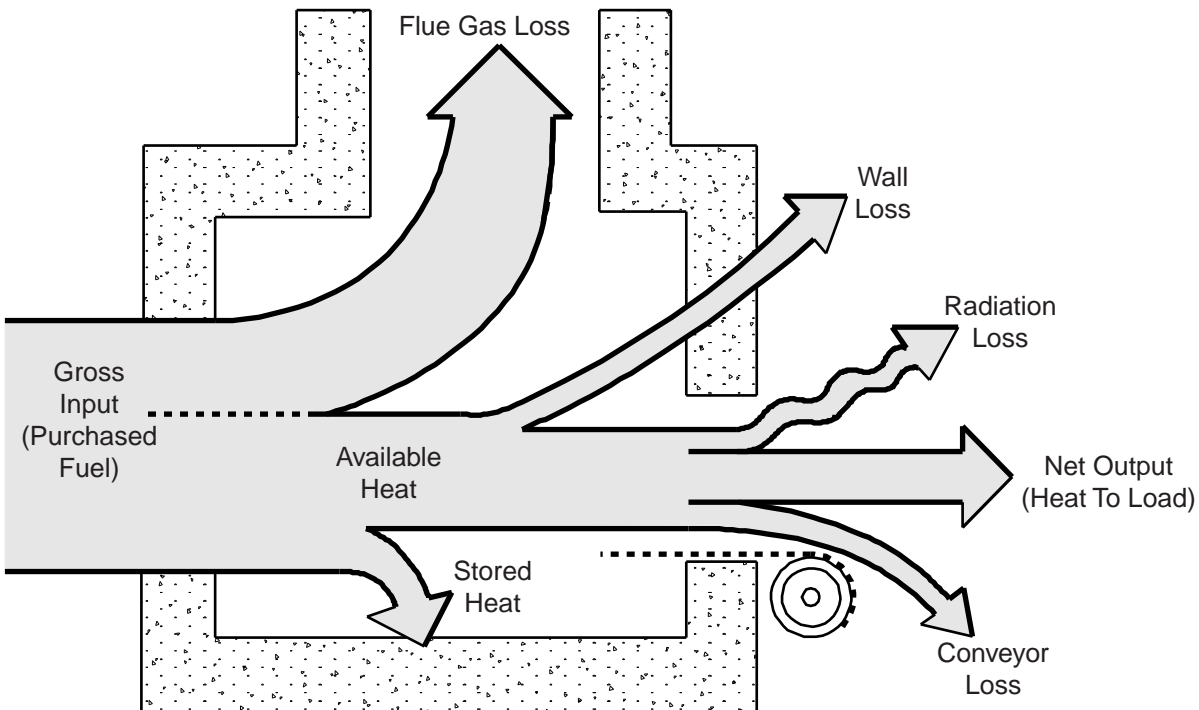

General heat balance in a fuel-fired heat processing device.

The terms used in heat balance calculations, and their definitions, are:

Gross heat input – the total amount of heat used by the furnace. It equals the amount of fuel burned multiplied by its heating value.

Available heat – heat that is available to the furnace and its workload. It equals gross input minus flue gas losses.

Flue gas losses – heat contained in flue gases as they are exhausted from the furnace.

Stored heat – heat absorbed by the insulation and structural components of the furnace or oven to raise them to operating temperature. This stored heat becomes a loss each time the furnace is cooled down, because it has to be replaced on the next startup. Heat storage can usually be ignored on continuous furnaces, because cooldowns and restarts don't occur often.

Wall losses – heat conducted out through the walls, roof and floor of the furnace due to the temperature difference between

the inside and outside. At a constant temperature, wall losses will remain constant regardless of production rate.

Radiation losses – heat lost from the furnace as radiant energy escaping through openings in walls, doors, etc.

Conveyor losses – heat which is stored in conveying devices such as furnace cars and conveyor belts and which is lost when the heated conveyor is removed from the furnace.

Net output – this is the heat that ultimately reaches the product in the oven or furnace.

On page 36 is a simplified worksheet for carrying out a heat balance. By following this format, you can determine the gross heat input required at maximum load and minimum load conditions, along with the furnace turndown and theoretical thermal efficiency.

HEAT BALANCE TABLE

Heat Balance Component	Maximum Load Conditions (Full Production Rate)	Minimum Load Conditions (Empty and Idling)
Heat to load	_____ Btu/hr	_____ 0 _____ Btu/hr
+ Wall losses	+ _____ Btu/hr	+ _____ Btu/hr
+ Radiation losses	+ _____ Btu/hr	+ _____ Btu/hr
+ Conveyor losses	+ _____ Btu/hr	+ _____ 0 _____ Btu/hr
= Available heat required	= _____ Btu/hr	= _____ Btu/hr
÷ Available heat, expressed as a decimal	÷ _____	÷ _____
= Gross heat input	= _____ Btu/hr	= _____ Btu/hr

$$\text{Furnace turndown} = \frac{\text{Gross heat input, maximum load conditions}}{\text{Gross heat input, minimum load conditions}} = \underline{\hspace{2cm}}$$

$$\text{Theoretical Thermal efficiency, \%} = \frac{\text{Heat to load, maximum load conditions}}{\text{Gross heat input, maximum load conditions}} \times 100 = \underline{\hspace{2cm}}$$

Supporting Calculations:

Heat to Load

Heat to load = lb per hour x specific heat x temperature rise.

Specific heats for many materials are listed on pages 37-39.

For most common metals and alloys, use the graphs on page 40. Simply multiply lb/hr production rate by the heat content picked from the graph.

Enter the heat to load under Maximum Load Conditions. Heat to load is usually zero under Minimum Load Conditions because no material is being processed through the oven or furnace.

Wall Losses:

Wall loss = Wall Area (inside) x heat loss, Btu/sq ft/hr.

Typical heat loss data are tabulated on page 44 .

If the roof and floor of the furnace are insulated with different materials than the walls, calculate their losses separately.

Add all the losses together and enter them in both the Maximum Load and Minimum Load columns above.

Caution: If the furnace is to be idled at a temperature lower than its normal operating temperature, wall losses will be correspondingly lower. Calculate them on the basis of the actual idling temperature.

Radiation Losses:

Radiation Losses = Opening Area x Black Body Radiation Rate x Shape Factor. See page 49 for radiation rates. Assume a Shape Factor of 1.

Conveyor Losses:

Treat the conveyor as you would a furnace load.

Conveyor Loss = Lb/hr of conveyor heated x specific heat x (Temperature leaving furnace – temperature entering furnace)

At minimum load, conveyor losses are usually zero because no material is being processed through the furnace.

Available Heat:

Available heat = Heat to load + wall losses + radiation losses + conveyor losses.

Calculate available heat for both maximum and minimum load conditions.

Next, consult the available heat charts (page 51) to determine the percent available heat for the fuel, operating temperature, and fuel/air ratio conditions of this application. Enter this figure as a decimal on both sides above.

Gross Input:

Gross Input = Available heat (Btu/hr) ÷ Available heat (decimal).

Figure this for both maximum and minimum load conditions.

Gross input, maximum conditions, is the maximum heating input required of the combustion system you select.

Furnace Turndown:

Divide maximum load gross input by minimum load gross input. The result is the furnace or oven turndown. Your combustion system must provide at least this much turndown or the furnace will overshoot setpoint on idle.

Theoretical Thermal Efficiency:

$$\% \text{ Efficiency} = \frac{\text{Heat to load, maximum load conditions} \times 100}{\text{Gross heat input, maximum load conditions}}$$

This is the maximum theoretical efficiency of the furnace, assuming it operates at 100% of rating with no production interruptions and with a properly adjusted combustion system.

Heat Storage

Heat Storage was left out of this analysis. Although it is a factor in furnace efficiency, burner systems are rarely sized on the heat storage needs of the furnace.

On continuous furnaces where cold startups occur infrequently, heat storage can usually be ignored without any major effect on efficiency calculations. On batch-type furnaces that cycle from hot to cold frequently, storage should be factored into efficiency calculations.

Heat Storage = Inside refractory surface area, ft² x Heat Storage Capacity, Btu/ft²

Heat storage capacities for typical types of refractory construction are tabulated on Page 44.

THERMAL PROPERTIES OF VARIOUS MATERIALS

Material	Density Lb/Cu Ft @60°F	Solid Specific Heat Btu/Lb-°F	Melting Point, °F	Latent Heat of Fusion, Btu/Lb	Liquid Specific Heat, Btu/Lb-°F	Boiling Point, °F	Latent Heat of Vaporization, Btu/Lb
Acetone	—	—	-138	33.5	0.530	128-134	225.5
Acetic Acid	65.8	0.540	62.6	44	0.462	244.4	152.8
Air	.0765	—	—	—	0.237	-311.0	91.7
Alcohol-Ethyl	49.26	0.232	-173.2	44.8	0.648	172.4	369.0
-Methyl	49.6	—	-142.6	29.5	0.601	150.8	480.6
Alumina	243.5	0.197	3722	—	—	—	—
Aluminum	166.7	0.248	1214	169.1	0.252	3272	—
Ammonia 32°	45.6	0.502	-83.0	195	1.099	-37.3	543.2
Andalusite	199.8	0.168	3290	—	—	—	—
Aniline	2.25	0.741	17.6	37.8	0.514	363	198
Antimony	422	0.054	1166	70.0	0.054	2624	—
Asbestos	124-174	0.195	—	—	—	—	—
Asphalt-Trinidad	97	0.55	190	—	0.55	—	—
-Gilsonite	67.5	0.55	300	—	0.55	—	—
Arsenic	357.6	0.082	Sublimes	—	—	—	—
Babbit 75 Pb 15 Sb 10 Sn	—	0.039	462	26.2	0.038	—	—
84 Sn 8 Sb 8 Cu	—	0.071	464	34.1	0.063	—	—
Bakelite	—	0.30	—	—	—	—	—
Beef Tallow	57-61	0.50	80-100	—	—	—	—
Beeswax	60	0.82	144	76.2	—	—	—
Benzene-Benzol	55	0.299	41.8	55.6	0.423	176.3	169.4
Beryllium	113.8	0.50	2345	621.9	0.425	5036	—
Bismuth	615	0.033	518	18.5	0.035	2606	—
Borax 105.5	0.238	1366	—	—	—	—	—
Brass 67 Cu 33 Zn	528	0.105	1688	71.0	0.123	—	—
85 Cu 15 Zn	—	0.104	1877	84.4	0.116	—	—
90 Cu 10 Zn	—	0.104	1952	86.6	0.115	—	—
Brick-Fireclay	137-150	0.240	—	—	—	—	—
-Red	118	0.230	—	—	—	—	—
-Silica	144-162	0.260	—	—	—	—	—
Bronze 90 Cu 10 Al	—	0.126	1922	98.6	0.125	—	—
90 Cu 10 Sn	—	0.107	1850	84.2	0.106	—	—
80 Cu 10 Zn 10 Sn	534	0.095	1832	79.9	0.109	—	—
Cadmium	540	0.038	610	19.5	0.074	1412	409
Calcium	96.6	0.170	1564	—	—	2709	—
Calcium Carbonate	175	0.210	Dec. 1517	—	—	—	—
Calcium Chloride	157	0.16	1422	97.7	—	>2912	—
Camphor	62.4	0.440	353	19.4	0.61	408	—
Carbon, Amorphous	129	0.241	6300	—	—	8721	—
Carbon, Disulfide	79.2	—	-166	—	0.24	115	150.8
Carbon, Graphite	138.3	0.184	6300	—	—	8721	—
Castor Oil	59.6	—	—	—	—	—	—
Celotex	—	0.40	—	—	—	—	—
Celluloid	—	0.36	—	—	—	—	—
Cellulose	95	0.320	—	—	—	—	—
Cement	—	0.20	—	—	—	—	—
Charcoal	18-38	0.165	—	—	—	—	—
Chlorine	0.190	0.19	-151	41.3	—	-30.3	121
Chloroform	95.5	—	-85	—	0.149	142.1	105.3
Chromite	281	0.22	3956	—	—	—	—
Chromium	437	0.12	2822	57.1	—	4500	—
Clay, Dry	112-162	0.224	3160	—	—	—	—
Coal (Anthracite)	—	0.31	—	—	—	—	—
Coal (Bituminous)	—	0.30	—	—	—	—	—
Coal Tar	76.7	0.413	196	—	—	325	—
Coal Tar Oil	—	—	—	—	0.34	390-910	136
Cobalt	555	0.145	2723	—	—	5252	—
Coke	—	0.2-0.38	—	—	—	—	—
Concrete	—	0.27	—	—	—	—	—
Copper	558	0.104	1982	90.8	0.111	4703	—
Cork	—	0.48	—	—	—	—	—
Corundum	250	0.304	3722	—	—	6332	—
Cotton	—	0.32	—	—	—	—	—
Cottonseed Oil	58	—	32	—	0.474	—	—
Cream	—	—	—	—	0.78	—	—
Cuprice Oxide	374-406	0.227	1944	—	—	—	—

T = Transformation Point Subl. = Sublimes Dec = Decomposes

THERMAL PROPERTIES OF VARIOUS MATERIALS (Cont'd)

Material	Density Lb/Cu Ft @60°F	Solid Specific Heat Btu/Lb-°F	Melting Point, °F	Latent Heat of Fusion, Btu/Lb	Liquid Specific Heat, Btu/Lb-°F	Boiling Point, °F	Latent Heat of Vaporization, Btu/Lb
Cyanite	225	0.227	3290	—	—	—	—
Diasporite	215	0.260	3722	—	—	—	—
Die Cast Metal:	—	—	—	—	—	—	—
87.3 Zn 8.1 Sn 4.1 Cu 0.5Al	—	0.103	780	48.3	0.138	—	—
90 Sn 4.5 Cu 5.5 Sb	—	0.070	450	30.3	0.062	—	—
80 Pb 10 Sn 10 Sb	—	0.038	600	17.4	0.037	—	—
92 Al 8 Cu	—	0.236	1150	163.1	0.241	—	—
Diphenyl	103	0.385	159	47	0.481	492	136.5
Dolomite	181	0.222	—	—	—	—	—
Dowtherm	58.8	0.53	180	—	—	500	123
Earth	—	0.44	—	—	—	—	—
Ebonite	—	0.35	—	—	—	—	—
Ether	45.9	—	-180.4	—	0.529	94.3	159.1
Fats	—	0.46	—	—	—	—	—
Fosterite	200	0.22	3470	—	—	—	—
Fuel Oil	—	—	—	—	0.45	—	—
Gasoline	42	—	—	—	0.514	176	128-146
German Silver	—	0.109	1850	86.2	0.123	—	—
Glass, Crown	—	0.16	—	—	—	—	—
Glass, Flint	—	0.13	—	—	—	—	—
Glass, Pyrex	—	0.20	—	—	—	—	—
Glass, Window (Soda Lime)	160	0.19	2192	—	—	—	—
Glass Wool	1.5	0.16	—	—	—	—	—
Glycerine	78.7	0.047	68	85.5	0.576	554	—
Gold	1205	0.032	1945	28.5	0.034	5371	29
Granite	—	—	—	—	—	—	—
Graphite	0.30-0.38	—	Subl. 6606	—	—	—	—
Gypsum	145	0.259	2480	—	—	—	—
Hydrochloric Acid	75	—	-12	—	—	—	—
Hydrogen	.0053	—	-434	27	—	-423	194
Hydrogen Sulfide	—	—	-117	—	—	-79	—
Iron	491	0.1162	2795	117	—	5430	—
Iron, Gray Cast	443	0.119	2330	41.7	—	—	—
Iron, White Cast	480	0.119	2000	59.5	—	—	—
Kerosene	—	—	—	—	0.470	—	108
Lead	711	0.032	621	9.9	0.032	3171	—
Lead Oxide	575-593	0.049	1749	—	—	—	—
Leather	—	0.36	—	—	—	—	—
Lucite	—	0.35	—	—	—	—	—
Light Oil	—	—	—	—	0.5	600	145-150
Linseed Oil	58	—	-5	—	0.441	—	—
Lipowitz Metal	—	0.041	140	17.2	0.041	—	—
Magnesite	187	0.200	Dec. 662	—	—	—	—
Magnesium	108.6	0.272	1204	83.7	0.266	—	—
Magnesium Oxide	223	0.23-0.30	5072	—	—	—	—
Manganese	500	0.171	2246	65.9	0.192	—	—
	—	—	T = 1958	T = 43.5	—	—	—
Marble	—	0.21	—	—	—	—	—
Mercury	885	0.033	-38	5.1	0.033	675	117
Mica	—	0.21	—	—	—	—	—
Milk	63.4	—	—	—	0.847	—	—
Molasses	87.4	—	—	—	0.60	—	—
Molybdenum	636	0.065	4748	—	—	8672	—
Monel	550	0.129	2415	117.4	0.139	—	—
Mallite	188.8	—	3290	—	0.175	—	—
Naptha	41.2	—	—	—	0.493	306	184
Napthalene	71.8	0.325	176	64.1	0.427	424.4	135.7
Neats Foot Oil	—	—	32	—	0.457	—	—
Nickel	556	0.134	2646	131.4	0.124	—	—
Nichrome	517	—	—	—	0.111	—	—
Nitric Acid	96.1	—	-43.6	—	0.445	186.8	207.2
Nitrogen	.0741	—	-346	11.1	—	-320	85.6
Nylon	—	0.55	—	—	—	—	—

T = Transformation Point Subl. = Sublimes Dec = Decomposes

THERMAL PROPERTIES OF VARIOUS MATERIALS (Cont'd)

Material	Density Lb/Cu Ft @60°F	Solid Specific Heat Btu/Lb-°F	Melting Point, °F	Latent Heat of Fusion, Btu/Lb	Liquid Specific Heat, Btu/Lb-°F	Boiling Point, °F	Latent Heat of Vaporization, Btu/Lb
Olive Oil	57.4	—	40	—	0.471	572	—
Oxygen	.0847	0.336	-361	5.98	0.394	-297	91.6
Paraffin	54-57	0.622	126	63	0.712	750	—
Petroleum	48-55	—	—	—	0.511	—	—
Phosphorus	114	0.189	111	9.05	—	536	234
Pitch, Coal Tar	62-81	0.45	86-300	—	—	—	—
Plaster of Paris	0.265	1.14	—	—	—	—	—
Platinum	1335	0.036	3224	49	0.032	7933	—
Porcelain	150	0.26	—	—	—	—	—
Potassium Nitrate	129.2	0.19	646	88	—	Dec. 752	—
Quartz	165.5	0.23	—	—	—	—	—
Resin-Phenolic	80-100	0.3-0.4	—	—	—	—	—
-Copals	68.6	0.39	300-680	—	—	—	—
Rhodium	773	0.058	3571	—	—	—	—
Rockwool	6	0.198	—	—	—	—	—
Rose's Metal	—	0.043	230	18.3	0.041	—	—
Rosin	68	0.5	170-212	—	—	—	—
Rubber	62-125	0.48	248	—	—	—	—
Salt-Rock	135	0.22	1495	—	—	2575	—
Sand	162	0.20	—	—	—	—	—
Sandstone	—	0.22	—	—	—	—	—
Sawdust	—	0.5	—	—	—	—	—
Shellac	75	0.40	170-180	—	—	—	—
Silica	180	—	3182	—	0.1910	4046	—
Silicon	155	0.176	2600	—	—	4149	—
Silicon Carbide	199	0.23	4082	—	—	Subl. 3032	—
Sillimanite	202	0.175	3290	—	—	—	—
Silk	84	0.33	—	—	—	—	—
Silver	656	0.063	1761	46.8	0.070	3634	—
Snow	—	0.5	32	—	—	—	—
Sodium Carbonate	151.5	0.306	1566	—	—	Dec.	—
Sodium Nitrate	140.5	0.231	597	116.8	—	1716	—
Sodium Oxide	142	0.231	Subl. 2327	—	—	—	—
Sodium Sulfate	168	0.21	—	—	—	—	—
Solder - 50 Pb 50 Sn	580	0.051	450	23	0.046	—	—
- 63 Pb 37 Sn	—	0.044	468	14.8	0.041	—	—
Steel - 0.3% C	491	0.129 (70-1330°)* 0.166 (1500-2500°)	—	—	—	—	—
Stone	168	0.20	—	—	—	—	—
Sugar - Cane	102	0.30	320	—	—	—	—
Sulfur	119-130	0.19	235	16.9	0.234	840	652
Sulfuric Acid	115.9	0.239	50.0	—	0.370	—	—
Talc	—	0.21	—	—	—	—	—
Tar-Coal	71-81	0.35	—	—	—	—	—
Tin	460	0.069	450	25.9	0.0545	4118	—
Titanium	281	0.14	3272	—	—	—	—
Toluene	53.7	—	—	—	0.40	230.5	150.3
Tungsten	1204	0.034	6098	—	—	10652	—
Turpentine	53.7	—	—	—	0.411	318.8	133.3
Type Metal-Linotype	—	0.036	486	21.5	0.036	—	—
Type Metal-Stereotype	670	0.036	500	26.2	0.036	—	—
Uranium	370	0.028	2071	—	—	—	—
Vanadium	372	0.115	3110	—	—	5432	—
Varnish	—	—	—	—	—	600	—
Water	62.37	0.480	32	144	1.00	212	970.4
Wood	19-56	0.33	—	—	—	—	—
Wood's Metal	—	0.041	158	17.2	0.042	—	—
Wool	81	0.325	—	—	—	—	—
Xylene	54.3	—	-18	—	0.411	288	147
Zinc	443	0.107	786	47.9	0.146	1706	—
Zinc Oxide	341	0.125	>3272	—	—	—	—
Zircon	293	0.132	4622	—	—	—	—
Zirconia	349	0.103	4919	—	—	—	—
Zirconium	399	0.067	3100	—	—	9122	—

T = Transformation Point Subl. = Sublimes Dec. = Decomposes

THERMAL CAPACITIES OF METALS & ALLOYS

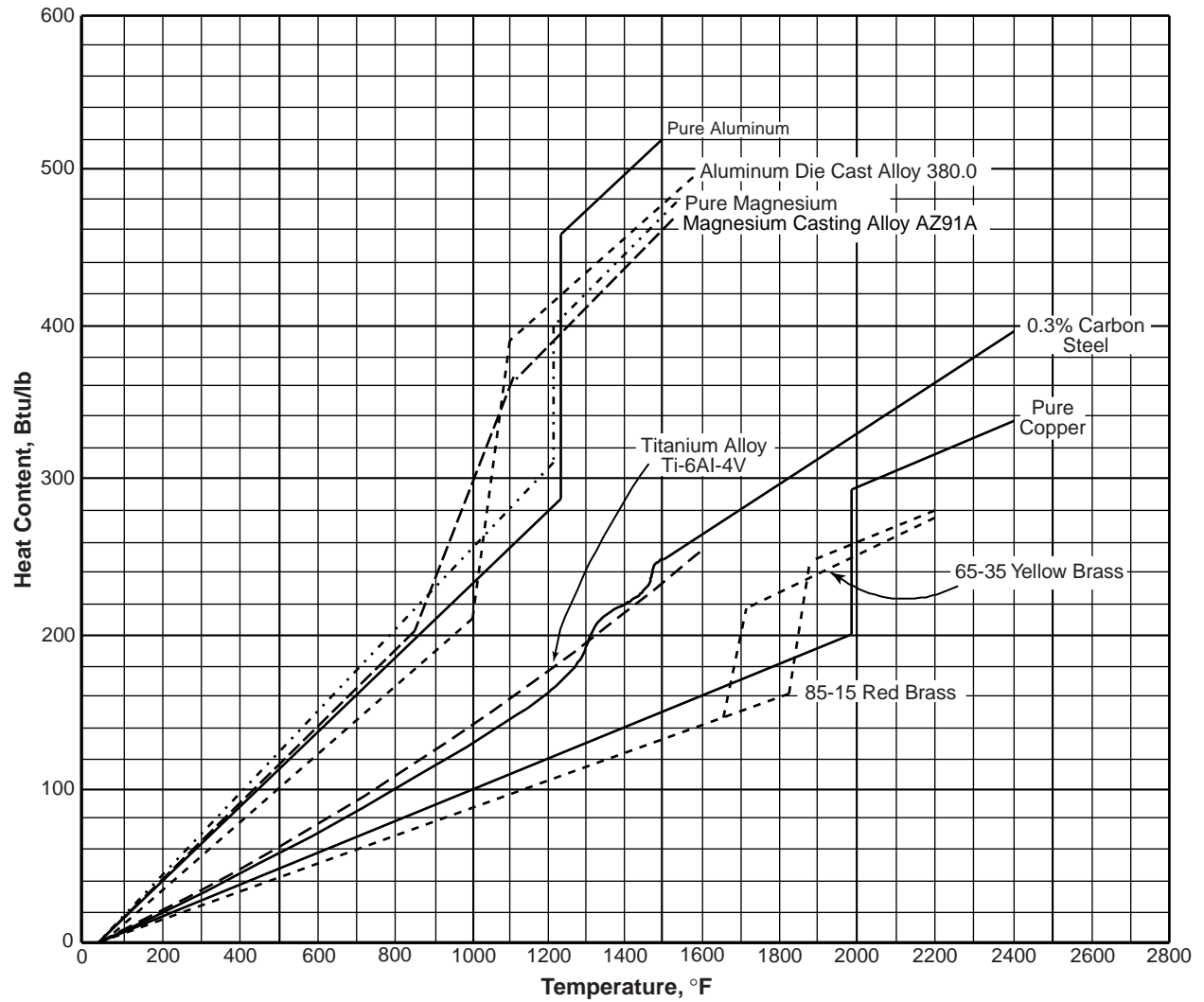
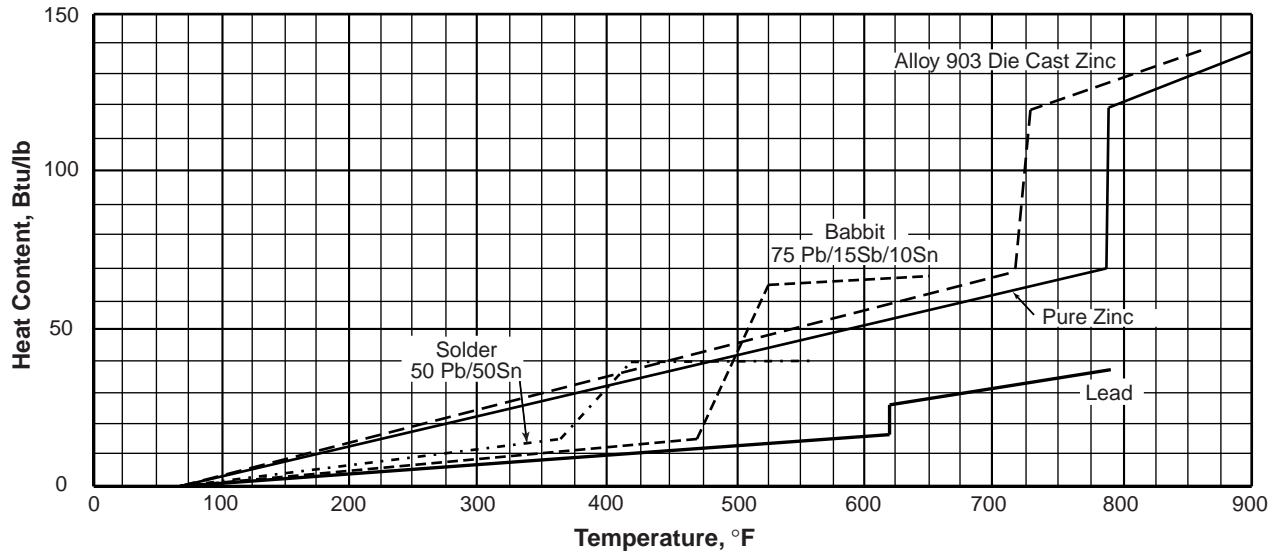

INDUSTRIAL HEATING OPERATIONS—TEMPERATURE & HEAT REQUIREMENTS

<u>Material</u>	<u>Operation</u>	<u>Approximate Temperature, °F</u>	<u>Heat Content of Material, Btu/lb*</u>
Aluminum	Age	190-470	30-100
	Anneal	645-775	130-190
	Homogenize	850-1150	175-300
	Hot Work (Extrude, Roll, Forge)	500-950	100-240
	Melt	1175-1500	370-550
	Solution Heat Treat	820-1025	170-280
	Stabilize	435-655	80-160
	Stress Relieve	650-775	130-190
	Asphalt	Melt	350-450
Babbitt	Melt	600-1000	60-75
Brass	Anneal	800-1450	70-150
	Hot Work (Extrude, Roll, Forge)	1150-1650	100-150
	Melt	1930-2370	230-290
	Recrystallize	550-700	40-70
	Stress Relieve	475	30-40
Bread	Bake	300-500	—
Bronze	Anneal	800-1650	70-170
	Hot Work (Extrude, Roll, Forge)	1200-1750	100-160
	Melt	1600-2350	220-320
	Stress Relieve	375-550	30-50
Brick, common fireclay	Burn	1900-2000	800-950
	Burn	2100-2200	900-1050
Cake	Bake	300-350	—
Candy	Cook	225-300	—
Cast Iron (Gray)	Anneal	1300-1750	290-420
	Austenitize (Harden)	1450-1700	330-410
	Melt	2800-2900	720-750
	Normalize	1600-1700	380-410
	Stress Relieve	700-1250	110-280
	Temper (Draw)	300-1020	35-175
Cast Iron, Ductile (Nodular Iron)	Anneal	1300-1650	290-390
	Austenitize (Harden)	1550-1700	360-410
	Normalize	1600-1725	380-415
	Stress Relieve	950-1250	160-275
	Temper (Draw)	800-1300	120-290
Cast Iron (Malleable)	Anneal (Malleablize)	1650-1750	290-420
	Austenitize (Harden)	1550-1600	360-380
	Temper (Draw)	1100-1300	190-290
Cement	Calcine	2800-3000	—
China	Fire	1900-2650	450-600
	Glaze	1500-1900	350-450
Coffee	Roast	600-800	—
Cookies	Bake	375-450	—
Copper	Anneal	500-1200	50-120
	Hot Work (Extrude, Roll, Forge)	1300-1750	130-180
	Melt	1970-2100	290-310
Enamel (Paint) (Porcelain)	Bake	250-450	—
	Fire	1700-1800	—

*Heat contained in material only. Does not include furnace or oven losses or available heat correction.

INDUSTRIAL HEATING OPERATIONS—TEMPERATURE & HEAT REQUIREMENTS (Cont'd)

<u>Material</u>	<u>Operation</u>	<u>Approximate Temperature, °F</u>	<u>Heat Content of Material, Btu/lb*</u>
Frit	Smelt	2000-2400	400-550
Glass	Melt	2200-2900	400-650
	Anneal	1000-1200	—
Gold	Melt	2000-2370	125-145
Lacquer	Dry	150-200	—
Lead	Melt	620-700	18-32
Lime	Calcine	2000-2200	—
Magnesium	Age	265-625	70-140
	Homogenize	200-800	30-190
	Hot Work (Extrude, Roll, Forge)	550-850	110-200
	Melt	1150-1550	375-490
	Solution Heat Treat	665-1050	150-350
	Stress Relieve	300-800	50-200
Meat	Smoke	100-150	—
Pie	Bake	500	—
Potato Chips	Fry	350-400	—
Sand	Dry	350-500	60-90
Sand Cores	Bake	400-450	70-80
Silver	Melt	1800-1900	155-165
Solder	Melt	400-500	40-45
Steel (Carbon & Alloy)	Anneal	1150-1650	150-270
	Austenitize	1320-1650	180-270
	Carbonitride	1300-1650	180-270
	Carburize	1600-1800	260-300
	Cyanide	1400-1600	210-260
	Hot Work (Forge, Roll)	2200-2400	360-400
	Nitride	925-1050	110-140
	Normalize	1500-1700	240-280
	Stress Relieve	450-1350	50-210
Steel (Stainless)	Anneal	1150-2050	150-340
	Austenitize (Harden)	1700-1950	280-320
	Hot Work (Forge, Roll)	1600-2350	260-390
	Stress Relieve	400-2050	30-340
	Temper (Draw)	300-1200	25-160
Tin	Melt	500-650	70-80
Titanium	Age	900-1000	120-140
	Anneal	1100-1600	150-250
	Hot Work (Roll, Forge)	1300-1900	180-310
	Solution Heat Treat	1550-1750	240-280
	Stress Relieve	1000-1200	140-170
Varnish	Cook	500-750	—
Zinc	Galvanize	850-900	130-140
	Melt	800-900	130-150
	Hot Work (Extrusion, Rolling)	200-575	10-55

*Heat contained in material only. Does not include furnace or oven losses or available heat correction.

CRUCIBLES FOR METAL MELTING – DIMENSIONS & CAPACITIES

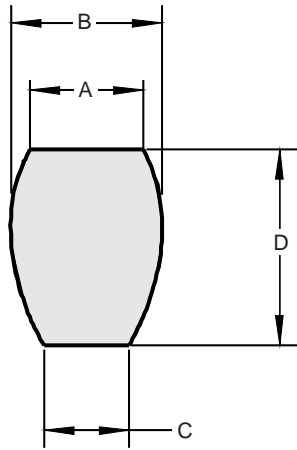

Size Number	Dimensions, inches				Approximate Capacity, lb			
	A, Top OD	B, Bilge OD	C, Bottom OD	D, Height	Aluminum	Red Brass	Copper	Magnesium
20	7 ¹ / ₁₆	8 ³ / ₁₆	6 ¹ / ₁₆	10 ¹⁵ / ₁₆	20	65	67	13
25	8 ³ / ₁₆	8 ⁷ / ₁₆	6 ¹ / ₂	10 ¹⁵ / ₁₆	25	81	84	16
30	8 ⁵ / ₁₆	9 ¹ / ₁₆	6 ¹³ / ₁₆	11 ¹ / ₂	30	97	100	20
35	9	9 ¹ / ₄	7 ¹ / ₈	12	35	113	117	23
40	9 ³ / ₁₆	10 ¹ / ₁₆	7 ¹ / ₁₆	12 ¹ / ₂	40	129	134	26
45	9 ⁷ / ₁₆	10 ¹ / ₁₆	7 ¹³ / ₁₆	13 ³ / ₁₆	45	146	151	29
50	10 ¹ / ₄	11 ¹ / ₈	8 ¹ / ₈	13 ³ / ₄	50	162	167	33
60	10 ¹³ / ₁₆	11 ¹ / ₁₆	8 ³ / ₁₆	14 ⁷ / ₁₆	60	194	201	39
70	11 ¹ / ₄	12 ³ / ₁₆	8 ¹⁵ / ₁₆	15 ¹ / ₁₆	70	226	234	46
80	11 ¹ / ₁₆	12 ¹ / ₁₆	9 ¹ / ₄	15 ⁵ / ₈	80	259	268	52
90	12 ¹ / ₈	13 ³ / ₈	9 ⁹ / ₁₆	16 ³ / ₁₆	90	291	301	59
100	12 ¹ / ₂	13 ¹ / ₂	9 ¹ / ₈	16 ¹ / ₁₆	100	323	335	65
125	13	14 ¹ / ₁₆	10 ⁵ / ₁₆	17 ³ / ₈	125	404	418	81
150	13 ³ / ₄	14 ⁷ / ₈	10 ¹ / ₄	18 ³ / ₈	150	485	502	98
175	14 ³ / ₈	15 ⁵ / ₁₆	11 ³ / ₈	19 ¹ / ₄	175	566	586	114
200	15	16 ¹ / ₄	11 ⁷ / ₈	20	200	657	669	130
225	15 ¹ / ₂	16 ¹³ / ₁₆	12 ⁵ / ₁₆	20 ³ / ₄	225	728	753	147
250	16	17 ⁵ / ₁₆	12 ¹ / ₁₆	21 ³ / ₈	250	808	837	163
275	16 ⁷ / ₁₆	17 ¹³ / ₁₆	13	22	275	889	921	179
300	16 ¹ / ₈	18 ¹ / ₄	13 ³ / ₈	22 ¹ / ₂	300	970	1004	195
400	18 ¹ / ₁₆	19 ¹ / ₁₆	14 ¹ / ₁₆	24 ⁵ / ₁₆	400	1293	1339	261

RADIANT TUBES – SIZING & INPUT DATA

TUBE EXTERNAL SURFACE AREA DATA

Tube OD, Inches	Straight Tube Sq. In. Per Foot of Length	180° Short Radius Elbow		180° Long Radius Elbow	
		℄ to ℄, in.	sq. in.	℄ to ℄, in.	sq. in.
3	113	6	89	9	133
3 ¹ / ₄	123	6	96	9	144
3 ¹ / ₂	132	6	104	9	155
3 ³ / ₄	141	6	111	9	167
4	151	8	158	12	237
4 ¹ / ₄	160	8	168	12	252
4 ¹ / ₂	170	8	178	12	267
4 ³ / ₄	179	8	188	12	281
5	188	10	247	15	370
5 ¹ / ₄	198	10	259	15	389
5 ¹ / ₂	207	10	271	15	407
5 ³ / ₄	217	10	284	15	426
6	226	12	355	18	533
6 ¹ / ₄	236	12	370	18	555
6 ¹ / ₂	245	12	385	18	577
6 ³ / ₄	254	12	400	18	600
8	302	16	632	24	947
8 ¹ / ₄	311	16	651	24	977
8 ¹ / ₂	320	16	671	24	1007

Maximum Heat Transfer Rates For Good Service Life of Alloy Tubes

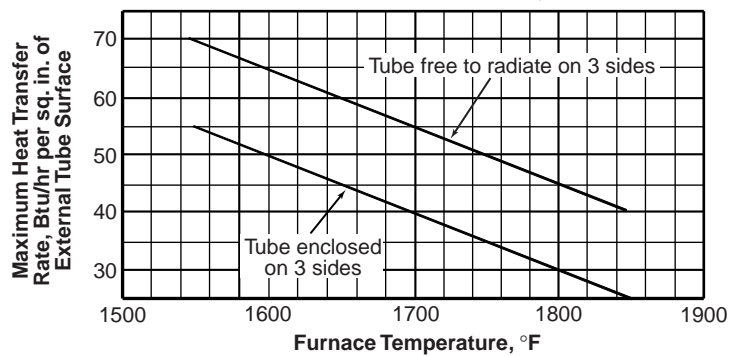

HEAT LOSSES, HEAT STORAGE & COLD FACE TEMPERATURES – REFRACTORY WALLS

Wall Construction	HL HS TC	Hot Face Temperature, °F							
		1000	1200	1400	1600	1800	2000	2200	2400
9" Hard Firebrick	HL	550	705	862	1030	1200	1375	1570	1768
	HS	12,500	15,400	18,400	21,500	24,700	27,950	31,200	34,500
	TC	282	320	355	387	418	447	477	505
9" Hard Firebrick + 4½" 2300° Insulating F.B.	HL	130	168	228	251	296	341	390	447
	HS	22,380	27,700	33,060	38,450	43,930	49,350	55,800	61,920
	TC	147	162	188	195	211	227	242	260
9" Hard Firebrick + 4½" 2000° Insulating F.B. + 2" Block Insulation	HL	111	128	155	185	209	244	282	325
	HS	23,750	29,650	35,640	41,940	48,420	54,890	61,410	68,120
	TC	138	144	156	169	179	193	205	218
4½" 2000° Insulating F.B.	HL	185	237	300	365	440	521	–	–
	HS	1180	1450	1750	2075	2400	2720	–	–
	TC	170	190	211	230	253	274	–	–
9" 2000° Insulating F.B.	HL	95	124	159	189	225	266	–	–
	HS	2260	2840	3420	4000	4620	5240	–	–
	TC	132	146	160	172	187	200	–	–
9" 2800° Insulating F.B.	HL	142	178	218	264	312	362	416	474
	HS	3170	3970	4790	5630	6480	7360	8230	9160
	TC	151	166	183	200	217	234	250	267
9" 2800° Insulating F.B. + 4½" 2000° Insulating F.B. +	HL	115	140	167	197	232	272	307	347
	HS	14,860	17,340	19,910	22,508	24,908	28,360	31,531	34,664
	TC	142	149	161	164	183	202	215	228
9" 2800° Insulating F.B. + 4½" 2000° Insulating F.B. + 2" Block Insulation	HL	71	91	112	134	154	184	204	230
	HS	10,670	14,836	19,220	23,771	27,491	31,654	35,078	38,252
	TC	119	127	136	147	156	168	177	187
9" 2800° Insulating F.B. + 3" Block Insulation	HL	114	142	172	201	232	264	298	333
	HS	7730	9765	11,760	13,810	15,880	17,973	20,084	22,209
	TC	139	150	163	175	188	200	212	224
4½" Dense Castable	HL	575	730	897	1075	1300	1525	1775	2030
	HS	5270	9520	11,310	13,060	14,820	16,120	18,300	20,030
	TC	282	319	356	393	430	467	504	541
9" Dense Castable	HL	315	410	500	627	694	844	947	1134
	HS	13,120	16,240	19,960	23,673	26,355	29,212	32,019	35,861
	TC	218	248	280	305	321	352	377	406
9" Plastic	HL	390	490	610	730	860	1000	1155	1332
	HS	17,825	21,735	25,640	29,610	33,345	37,125	41,040	44,415
	TC	232	261	290	319	348	378	407	436
8" Ceramic Fiber – Stacked Strips, 8 #/cu ft Density	HL	27	45	64	86	114	146	178	216
	HS	850	1018	1190	1358	1528	1692	1823	2039
	TC	95	105	115	126	138	152	165	180
10" Ceramic Fiber – Stacked Strips, 8 #/cu ft Density	HL	16	35	54	76	94	120	142	172
	HS	1054	1262	1473	1683	1895	2098	2262	2528
	TC	92	101	110	119	129	140	151	163
12" Ceramic Fiber – Stacked Strips, 8 #/cu ft Density	HL	13	27	43	60	79	98	118	143
	HS	1265	1517	1775	2033	2276	2518	2714	3034
	TC	91	97	104	112	121	130	140	151
9" Hard Firebrick + 3" Ceramic Fiber Veneer, 8 #/cu ft Density	HL	177	240	309	383	463	642	721	800
	HS	1920	3680	5430	7178	9219	11,200	12,503	14,891
	TC	170	191	214	235	259	305	320	341
9" 2800° Insulating F.B. + 3" Ceramic Fiber Veneer, 8 #/cu ft Density	HL	102	125	151	183	227	274	325	408
	HS	1150	2012	2910	3795	4576	5402	6272	7450
	TC	134	143	153	167	183	200	217	242
9" Dense Castable + 3" Ceramic Fiber Veneer, 8 #/cu ft Density	HL	170	221	273	329	381	487	559	635
	HS	1910	3603	5340	7083	8899	10,576	12,136	14,149
	TC	164	183	202	222	240	270	289	307

HL = Heat Loss, Btu/hr – sq ft HS = Heat Storage, Btu/sq ft TC = Cold Face Temperature, °F
 Note: These values are typical for the materials listed and are sufficiently accurate for estimating purposes. Values for specific brands of refractories may differ.

AIR HEATING & FUME INCINERATION HEAT REQUIREMENTS USING "RAW GAS" BURNERS

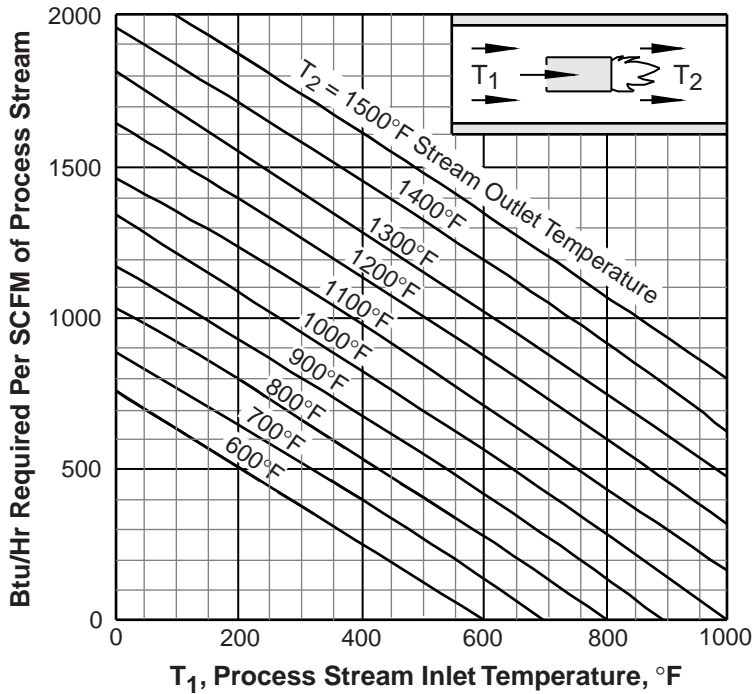

These curves show the heat input required per scfm of process air stream where the burner derives its combustion air from the stream. They can also be used to calculate heat requirements for direct-fired fume incinerators, provided:

1. Oxygen content of the fume stream is at least 20%, and
2. Combustible solvents in the fume stream make a negligible contribution to the heat input.

The curves are calculated from the relationship.

$$\text{Btu/hr} = \frac{\text{scfm} \times 1.1 \times (T_2 - T_1)}{\text{available heat, expressed as a decimal}}$$

For high stream inlet and outlet temperatures, they produce more accurate results than the traditional relationship

$$\text{Btu/hr} = \text{scfm} \times 1.1 \times (T_2 - T_1),$$

which does not take variations of available heat into account.

If the application requires a burner with a separate combustion air source, use the curves below.

AIR HEATING & FUME INCINERATION HEAT REQUIREMENTS USING BURNERS WITH SEPARATE COMBUSTION AIR SOURCES

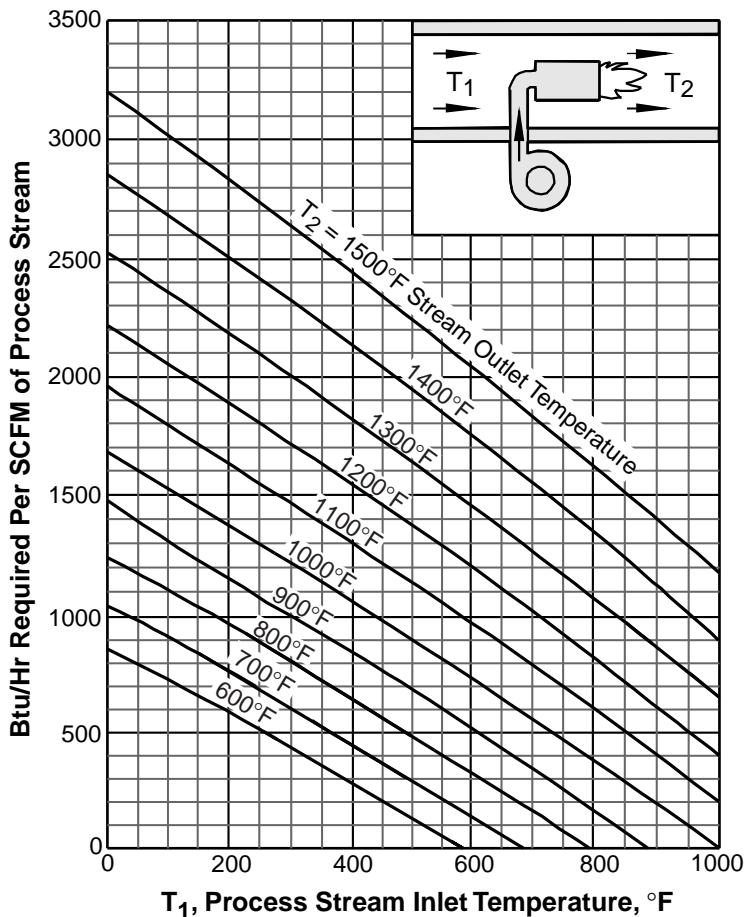

These curves show the heat input required per scfm of process air stream using a burner with a separate combustion air source. They are calculated from the relationship:

$$\text{Btu/hr} = \frac{\text{scfm} \times 1.1 \times (T_2 - T_1)}{\text{available heat, expressed as a decimal}}$$

See above for heat requirements of systems using a "raw gas" burner.

FUME INCERATION – SELECTION & SIZING GUIDELINES

I. Process Information Required

- A. Fume stream flow rate, scfm or acfm. (If acfm, specify temperature at which flow is measured.) Maximum and minimum flow rates are required.
- B. Fume stream temperature at inlet to burner at maximum and minimum flow rates.
- C. Oxygen content of fume stream.
- D. Amount of particulates or other non-volatile matter in fume stream.
- E. Incineration temperature required, typically: 600-900°F for catalytic incinerators 1200-1500°F for thermal incinerators.
- F. Residence time required in combustion chamber, typically, 0.3 to 0.7 seconds.

II. Burner Type Selection

Two basic types of burners are used to fire fume incinerators: raw gas burners, which obtain their combustion air from the incoming fume stream, and fresh air burners, which obtain theirs from an external source.

Raw gas burners permit higher fuel efficiency, but they can't be used under as wide a variety of operating conditions. The table below provides some general guidelines for burner selection.

Selection Factor	Raw Gas Burner	Fresh Air Burner
Oxygen content of fume stream	18-21%	ok
	13-18%	maybe-check mfr.
	below 13%	no
Fume stream temperature entering burner	Up to 1100°F	Depends on burner-check mfr.
	Over 1100°F	no
Particulates or other non-volatiles in stream	None	ok
	Low	probably ok
	Heavy	Depends on burner-check mfr.

III. Calculating Burner Input

- A. For raw gas burners, use the chart on the top of page 45.
- B. For fresh air burners use the chart on the bottom of page 45.
These charts give Btu/hr required per scfm of fume stream. Multiply this figure by the fume stream flow rate, in scfm, to determine total burner heat input.
- C. If the burner will take part of its combustion air from the fume stream and the rest from an outside source, heat input can be closely estimated with this method:

From page 45, determine Btu/hr required with a raw gas burner. Call this B_r .

From page 45, determine Btu/hr required with a 100% fresh air burner. Call this B_f .

Btu/hr (partial fresh air) =

$$B_r + \frac{\% \text{ fresh combustion air}}{100} (B_f - B_r)$$

IV. Sizing Profile Plates

If the burner is the type that is placed inside the fume duct, it has to be surrounded with a profile plate. Fumes are forced to pass through the gap between the profile plate and burner, ensuring that they mix completely with the burner flame.

To size the profile gap, you need to know:

1. Temperature of the fume stream passing over the burner,
2. Fume stream pressure drop required across the profile gap (see burner manufacturer's catalog data).

Refer to the chart on page 17. Locate the required pressure drop at the bottom of the chart, then read up to the appropriate temperature curve and left to the stream velocity. Divide this velocity into the fume stream flow expressed in acfm:

$$\text{Profile gap, sq ft} = \frac{\text{Fume stream flow, acfm}}{\text{Fume stream velocity, ft/min}}$$

For best results, the profile gap must be uniform width around the perimeter of the burner. Check manufacturer's literature for specific recommendations on design and location of profile plates.

NOTE: The air diffuser openings in some types of burners are considered part of the profile area. If so, deduct the area of these openings from the total profile area. The result will be the area of the gap around the burner.

V. Sizing Downstream Combustion Chamber

A. Chamber Cross-sectional area (A), Good practice requires no great than 30 ft/sec velocity in the combustion chamber, so

$$A, \text{ sq ft} = \frac{\text{acfm of heated fume stream}}{1800}$$

B. Combustion chamber length (L) is dictated by the required residence time.

$L, \text{ feet} = \text{Stream velocity} \times \text{residence time.}$

If, for example, velocity is 30 ft/sec, and residence time is 0.5 seconds, L is 15 feet.

WARNING! Incineration of fume streams containing compounds of chlorine, fluorine, or sulfur will produce combustion products which may be toxic or corrosive, or both. Consult with environmental authorities before considering fume incineration.

LIQUID HEATING – BURNER SIZING GUIDELINES

I. Tank Heating

To determine the immersion burner size for heating a liquid tank, conduct two heat balances—one for heat-up requirements, the other for steady-state operating requirements. Use the larger of the two Btu inputs obtained from these calculations.

A. Heat Balance – Heatup Requirements

1. Heat to water

$$\text{Btu/hr} = \frac{\text{Lb water} \times \text{temperature rise, } ^\circ\text{F}}{\text{heatup time required, hr}}$$

or

$$\text{Btu/hr} = \frac{8.3 \times \text{gallons water} \times \text{temperature rise, } ^\circ\text{F}}{\text{heatup time required, hr}}$$

or

$$\text{Btu/hr} = \frac{62.4 \times \text{cu ft water} \times \text{temperature rise, } ^\circ\text{F}}{\text{heatup time required, hr}}$$

Common practice allows the following heatup times for various size tanks:

Tank Capacity		Heatup
Gallons	Cu Ft	Time, hr
0-375	0-50	2
375-750	50-100	4
750-1500	100-200	6
Over 1500	Over 200	8

2. Surface losses – evaporation & radiation

$$\text{Btu/hr} = \text{Exposed bath surface} \times \text{heat loss from Table 1.}$$

3. Tank wall losses

$$\text{Btu/hr} = \text{Total sq ft of tank walls \& bottom} \times \text{wall loss from Table 1.}$$

4. Tank heat storage

$$\text{Btu/hr} = \frac{\text{Total sq ft, tank walls \& bottom} \times \text{storage, Table 1.}}{\text{heatup time required, hr}}$$

5. Total heatup requirements

$$\begin{aligned} &\text{Heat to water} \\ &+ \text{Surface losses} \\ &+ \text{Tank wall losses} \\ &+ \text{Tank heat storage} \\ &= \text{Total heatup requirement} \end{aligned}$$

B. Heat Balance – Steady State Heat Requirements

1. Heat to workload

$$\text{Btu/hr} = \frac{\text{Lb of work processed}}{\text{hr}} \times$$

specific heat x temperature rise, $^\circ\text{F}$

(Work weight must include all baskets & fixtures)

Specific heat of steel is 0.14 Btu/lb - $^\circ\text{F}$.

See pages 37 to 39 for other materials.

2. Surface losses – evaporation & radiation

Same as Step A.2.

3. Tank wall losses

Same as Step A.3.

4. Heat to makeup water

$$\text{Btu/hr} = \text{makeup rate, gal/hr} \times 8.3 \times \text{temperature rise, } ^\circ\text{F}$$

5. Total steady state heat requirement

Heat to workload

+ Surface losses

+ Tank wall losses

+ Heat to makeup water

= Total steady state requirement

C. Compare the heat requirements calculated in Steps A.5 and B.5. Select the larger of the two. (This is the net hourly input to the tank.)

D. Gross Heat Input (Burner Firing Rate)

$$\text{Gross Input, Btu/hr} = \frac{\text{Net Input from A.5 or B.5}}{\% \text{ Efficiency required}} \times 100$$

Efficiency is a function of immersion tube length and burner firing rate. 70% is a commonly used efficiency rating.

E. Immersion Tube Sizing

See burner manufacturer's product literature for tube sizing recommendations.

Table 1. Tank losses & storage

Liquid Temperature, $^\circ\text{F}$	Surface Losses, Btu/sq ft-hr			Wall Losses, Btu/sq ft-hr				Heat Storage, Btu/sq ft	
	Evapor- ation*	Radi- ation	Total*	Insulation Thickness				Steel Thickness	
				None	1"	2"	3"	1/8"	1/4"
90	80	50	130	50	12	6	4	21	42
100	160	70	230	70	15	8	6	28	56
110	240	90	330	90	19	10	7	35	70
120	360	110	470	110	23	12	9	42	84
130	480	135	615	135	27	14	10	49	98
140	660	160	820	160	31	16	12	56	112
150	860	180	1040	180	34	18	13	63	126
160	1100	210	1310	210	38	21	15	70	140
170	1380	235	1615	235	42	23	16	77	154
180	1740	260	2000	260	46	25	17	84	168
190	2160	290	2450	290	50	27	19	91	182
200	2680	320	3000	320	53	29	20	98	196
210	3240	360	3590	360	57	31	22	105	210
220	4000	420	4420	380	62	33	23	112	224
250	—	510	—	510	70	40	25	133	266
275	—	600	—	600	81	45	29	151	301
300	—	705	—	705	92	51	33	168	336
325	—	850	—	850	103	57	36	186	371
350	—	990	—	990	114	63	40	203	406
400	—	1335	—	1335	138	75	49	238	476

*Water or water-based solutions only.

II. Spray Washers

Three methods are presented for calculating spray washer heat requirements. The first is the most accurate, making use of detailed heat loss factors. The other two are rule-of-thumb methods. While not as accurate as method A, they are useful for quickly estimating burner inputs.

A. Heat Loss Method

1. Data required:

- Gpm capacity of spray nozzles
- Height & width of washer housing (hood)
- Height & width of opening through which work passes
- Liquid pressure head
- Liquid temperature
- Location of stage in washer

2. Heat Loss factors

From Table 2, find the heat loss factors for housing height opening width housing width liquid pressure opening height liquid temperature

Add all these factors together to get the combined factor, f.

3. Stage location multiplier, M

Location	Multiplier
Entrance Stage	1.75
Intermediate Stage	1.00
After a Cold Rinse	1.25
Exist Stage	1.50

4. Calculation of Gross Burner Input

$$\text{Btu/hr} = \text{Gpm} \times 500 \times f \times M$$

This method yields gross burner input because an immersion tube efficiency of 70% has already been assumed in the heat loss factors.

Table 2. Spray Washer Heat Loss Factors

Housing				Opening				Liquid			
Wide Ft.	f	High Ft.	f	Wide Ft.	f	High Ft.	f	Press. PSIG	f	Temp. °F	f
2	.7			1	.8					140	.4
3	.8			2	.9	1	.5	5	.4	145	.5
4	.9	1	.3	3	1.0	2	.6	7.5	.5	150	.6
5	1.0	2	.4	4	1.1	3	.7	10	.6	155	.7
6	1.1	3	.5	5	1.2	4	.8	12.5	.7	160	.8
7	1.2	4	.6	6	1.3	5	.9	15	.8	165	.9
8	1.3	5	.7	7	1.4	6	1.0	17.5	.9	170	1.0
9	1.4	6	.8	8	1.5	7	1.1	20	1.0	175	1.3
10	1.5	7	.9	9	1.6	8	1.3	22.5	1.2	180	1.6
11	1.6	8	1.0	10	1.7	9	1.5	30	1.4	185	1.9
12	1.7	9	1.1	11	1.8	10	1.7	32.5	1.6	190	2.2
13	1.8	10	1.2	12	1.9	11	1.9	35	1.8		
14	1.9	11	1.3	13	2.0	12	2.1	37.5	2.0		
15	2.0	12	1.4	14	2.1	13	2.3	40	2.2		
16	2.1	13	1.5	15	2.2	14	2.5	50	2.6		
17	2.2	14	1.6	16	2.2	14	2.5	100	3.5		

B. Temperature Drop Rule of Thumb

1. Data required:

- Gpm capacity of spray nozzles
- Temperature of liquid
- Tube efficiency (usually 70%)

2. Approximate temperature drop of water. Table 3 lists the approximate loss in water temperature as it is sprayed onto the workload.

Table 3. Water Temperature Drop

Water Temperature, °F	Temperature Drop, °F
150	5
160	6
170	7
180	8
190	9
200	10

3. Calculation of gross burner input.

$$\text{Btu/hr} = \frac{\text{Gpm} \times 500 \times \text{Temp Drop}}{\% \text{ Efficiency}} \times 100$$

4. Tank sizing

$$\text{Tank capacity} = 3 \times \text{Gpm spray capacity}$$

C. Quick Method Rule of Thumb

Btu/hr gross burner input =

$$\frac{4000 \times \text{Gpm sprayed @ 30 psi}}{\% \text{ Efficiency}} \times 100$$

Capacities of spray nozzles are listed in Table 4.

Table 4. Capacities of Spray Nozzles

PSI Press	Ft. Hd. (Approx.)	Gallons per minute of water through a nozzle diameter of:						
		1/4"	5/16"	3/8"	7/16"	1/2"	5/8"	3/4"
5	11.5	3.3	5.2	7.4	10.2	13.3	20.8	30.0
10	23.0	4.7	7.3	10.4	14.3	18.7	29.3	42.3
15	35.0	5.8	9.1	12.9	17.7	23.2	36.2	52.3
20	46.5	6.7	10.5	14.8	20.7	26.7	41.8	60.5
25	57.5	7.4	11.7	16.6	22.7	29.7	46.8	67.0
30	68.5	8.1	12.9	18.2	24.8	32.4	50.7	73.0
35	81.0	8.8	13.8	19.7	27.0	35.2	55.1	79.5
40	92.5	9.4	14.8	21.3	28.8	37.7	58.9	85.0
45	104.0	10.0	15.7	22.4	30.6	39.9	65.1	90.0
50	115.0	10.5	16.5	23.5	32.1	42.0	65.7	94.6
55	126.5	11.0	17.3	24.7	33.7	44.1	68.9	99.5
60	138.0	11.0	18.1	25.8	35.2	46.1	72.1	104.0
65	150.0	12.0	18.8	26.9	36.7	48.0	75.0	108.2
70	162.0	12.4	19.6	27.9	38.1	49.7	77.9	112.0
75	172.0	12.9	20.2	28.9	39.4	51.5	80.6	116.0
80	184.5	13.3	20.9	29.9	40.7	53.3	83.1	119.9
85	195.0	13.7	21.5	30.7	41.8	54.7	85.5	123.5
90	205.0	14.0	22.0	31.4	42.9	56.2	87.7	126.7
95	214.5	14.4	22.6	32.1	43.9	57.5	89.8	129.5
100	224.0	14.6	23.1	32.8	44.8	58.7	91.7	132.0

Above values are based on an orifice discharge coefficient of .80

ORIFICE FLOW EQUATION:

$$Q = 19.65 C D^2 \sqrt{H}$$

WHERE:

- Q = Gallons per minute
- D = Diameter of orifice in inches
- H = Pressure drop across orifice in feet head
- C = Orifice discharge coefficient

BLACK BODY RADIATION

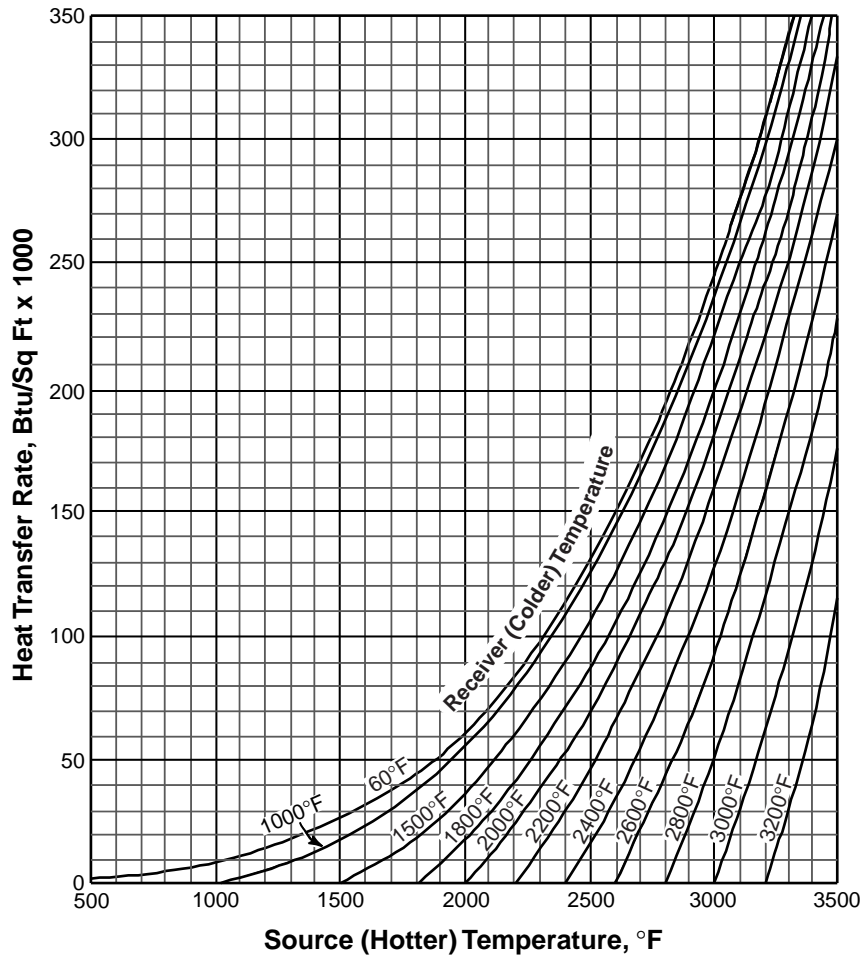

These curves are plotted from the relationship

$$Q = \frac{AK (T_1^4 - T_2^4)}{\frac{1}{P_1} + \frac{1}{P_2} - 1} \quad (\text{page 8.2})$$

where P_1 & P_2 equal 1, that is, the heat source and receiver both have emissivities of 1.0, and they are arranged so there is no barrier to heat transfer between them.

THERMOCOUPLE DATA

ANSI Calibration Code

	<u>B</u>	<u>E</u>	<u>J</u>	<u>K</u>	<u>R</u>	<u>S</u>	<u>T</u>
Useful Temp. Range, °F	1600-3100	32-1600	400-1400	700-2300	1800-2700	1800-2700	-300 + 700
Positive Element	Pt-30%Rh*	Chromel**	Iron	Chromel**	Pt-13%Rh*	Pt-10%Rh*	Copper
Negative Element	Pt-6%Rh*	Constantan	Constantan	Alumel**	Pt*	Pt*	Constantan
Color Coding							
Positive Element	Gray	Purple	White	Yellow	Black	Black	Blue
Negative Element	Red	Red	Red	Red	Red	Red	Red
Outer Insulation on Duplex Wire	Gray	Purple or Brown/Purple	Black or Brown/Black	Yellow or Brown/Yellow	Green	Green	Blue or Brown/Blue
Plugs & Jacks	Gray	Purple	Black	Yellow	Green	Green	Blue

*Pt = Platinum, Rh = Rhodium

**Trademarks - Hoskins Mfg. Co.

How to Determine Thermocouple Polarity if Wire Identification is Missing:

Types B, R, and S: Gently flex the ends of both wires. The stiffer wire is the positive element.

Type K: Negative element is slightly magnetic.

Type J: Positive element is magnetic.

Type T: Positive element has characteristic pinkish-orange color of copper.

ORTON STANDARD PYROMETRIC CONES TEMPERATURE EQUIVALENTS

Cone Type Heating Rate Cone number	Large Regular		Large Iron Free		Self-Supporting		Self-Iron Free		Small Regular 540°F/hr	Small PCE 270°F/hr	Cone Type Heating Rate Cone number
	108°F/hr	270°F/hr	108°F/hr	270°F/hr	108°F/hr	270°F/hr	108°F/hr	270°F/hr			
022	1074	1092			1087	1094			1157		022
021	1105	1132			1112	1143			1195		021
020	1148	1173			1159	1180			1227		020
019	1240	1265			1243	1267			1314		019
018	1306	1337			1314	1341			1391		018
017	1348	1386			1353	1391			1445		017
016	1407	1443			1411	1445			1517*		016
015	1449	1485			1452	1488			1549*		015
014	1485	1528			1488	1531			1616		014
013	1539	1578			1542	1582			1638		013
012	1571	1587			1575	1591			1652		012
011	1603	1623			1607	1627			1684		011
010	1629*	1641*	1623	1656	1632	1645	1627	1659	1686*		010
09	1679*	1693*	1683	1720	1683	1697	1686	1724	1751*		09
08	1733*	1751*	1733	1773	1737	1755	1735	1774	1801*		08
07	1783*	1803*	1778	1816	1787	1807	1780	1818	1846*		07
06	1816*	1830*	1816	1843	1819	1834	1816	1845	1873*		06
05 1/2	1852	1873	1852	1886	1855	1877	1854	1888	1908		05 1/2
05	1888*	1915*	1890	1929	1891	1918	1899	1931	1944*		05
04	1922*	1940*	1940	1967	1926	1944	1942	1969	2008*		04
03	1987*	2014*	1989	2007	1990	2017	1990	2010	2068*		03
02	2014*	2048*	2016	2050	2017	2052	2021	2052	2098*		02
01	2043*	2079*	2052	2088	2046	2082	2053	2089	2152*		01
1	2077*	2109*	2079	2111	2080	2113	2082	2115	2154*		1
2	2088*	2124*	Not Manufactured		2091	2127	Not Manufactured		2154*		2
3	2106*	2134*	2104	2136	2109	2138	2109	2140	2185*		3
4	2134*	2167*			2142	2169			2208*		4
5	2151*	2185*			2165	2199			2230*		5
6	2194*	2232*			2199	2232			2291*		6
7	2219*	2264*			2228	2273			2307*		7
8	2257*	2305*			2273	2314			2372*		8
9	2300*	2336*			2300	2336			2403*		9
10	2345*	2381*			2345	2381			2426*		10
11	2361*	2399*			2361	2399			2437*		11
12	2383*	2419*			2383	2419			2471*	2439*	12
13	2410*	2455*			2428	2458			2460	2460*	13
13 1/2	Not Manufactured				2466	2493			Not Manufactured		13 1/2
14	2530*	2491*			2489	2523			2548	2548*	14
14 1/2	Not Manufactured				2527	2568			Not Manufactured		14 1/2
15	2595*	2608*			2583	2602			2606	2606*	15
15 1/2	Not Manufactured				2617	2633			Not Manufactured		15 1/2
16	2651*	2683*			2655	2687			2716	2716*	16
17	2691*	2705*			2694	2709			2754	2754*	17
18	2732*	2743*			2736	2746			2772	2772*	18
19	2768*	2782*			2772	2786			2806	2806*	19
20	2808*	2820*			2811	2824			2847	2847*	20
21	2847*	2856*			2851	2860				2883*	21
23	2887*	2894*			2890	2898				2921*	23
26	2892*	2921*								2950*	26
27	2937*	2961*								2984*	27
28	2937*	2971*								2995*	28
29	2955*	2993*								3018*	29
30	2977*	3009*								3029*	30
31	3022*	3054*								3061*	31
31 1/2	ND	ND								3090*	31 1/2
32	3103*	3123*								3123*	32
32 1/2	3124*	3146*								3135*	32 1/2
33	3150*	3166*								3169*	33
34	3195*	3198*								3205*	34
35	3243*	3243*								3245*	35
36	3268*	3265*								3279*	36
37	ND	ND								3308	37
38	ND	ND								3362	38
39	ND	ND								3389	39
40	ND	ND								3425	40
41	ND	ND								3578	41
42	ND	ND								3659	42

The temperature equivalent tables are designed to be a guide for the selection of cones to use during firing. The temperature listed may only have a relative value to the user. However, the values do provide a good starting point and once the proper cones are determined for a particular firing condition, excellent firing control can be maintained. **NOTES:** ND = Not determined *Temperature equivalents as determined by the National Bureau of Standards by H.P. Beerman (See Journal of the American Ceramic Society Volume 39, 1956) Large cones at 2 inch mounting height, Small & PCE cones at 15/16 inch.

1. The temperature equivalents in this table apply only to Orton Standard Pyrometric Cones, heated at the rate indicated in air atmosphere.
2. The rates of heating shown at the head of each column of temperature equivalents were maintained during the last several hundred degrees of temperature rise.
3. The temperature equivalents are not necessarily those at which cones will deform under firing conditions different from those under which the calibration determination were made.
4. For reproducible results, care should be taken to insure that the cones are set in a plaque with the bending face at the correct angle of 8° from the vertical with the cone tips at a uniform height above the plaque.

CHAPTER 8 – COMBUSTION DATA

AVAILABLE HEAT CHARTS

Available heat for Birmingham Natural Gas (1002 Btu/cu ft, 0.60 sp gr) vs. % Excess Air and Combustion Air Temperature (at 10% excess air).

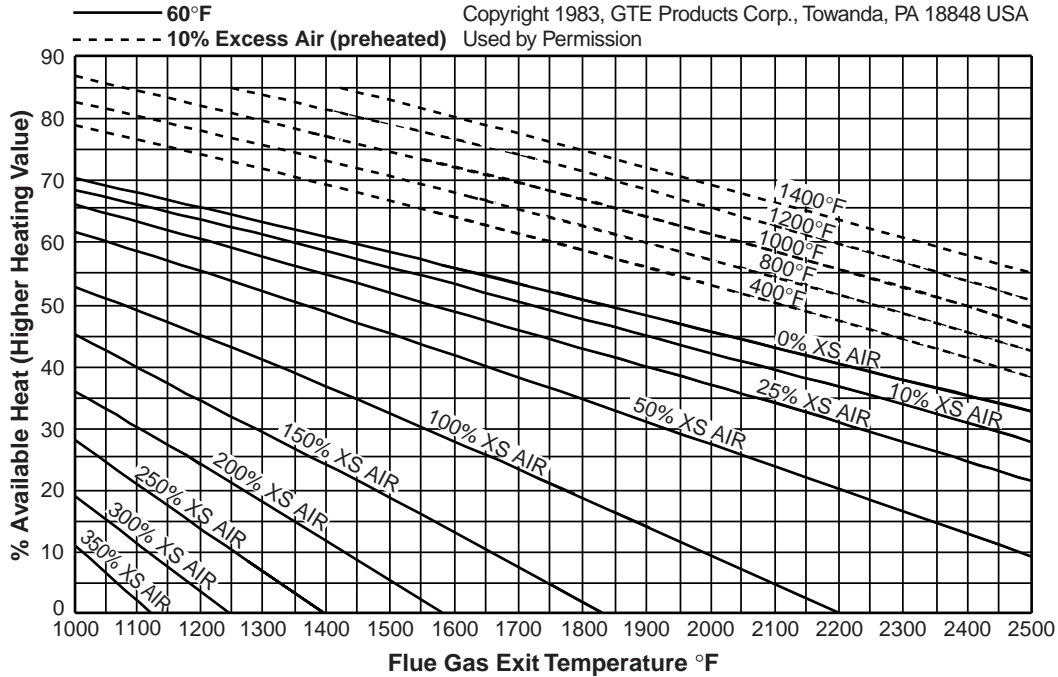

AVAILABLE HEAT FOR VARIOUS FUEL GASES

These curves assume 0% excess air. The excess air curves above for Birmingham Natural Gas can be used for butane, propane, natural, mixed, coke oven, & carbureted water gas without more than 5% error in the available heat.

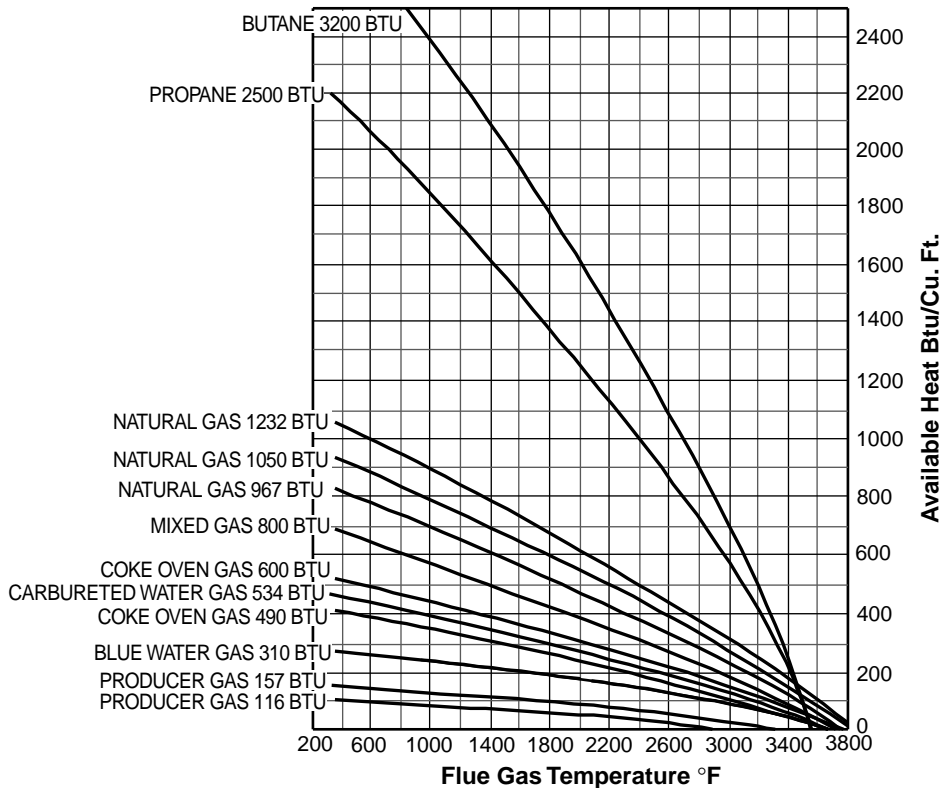

FLUE GAS ANALYSIS CHART

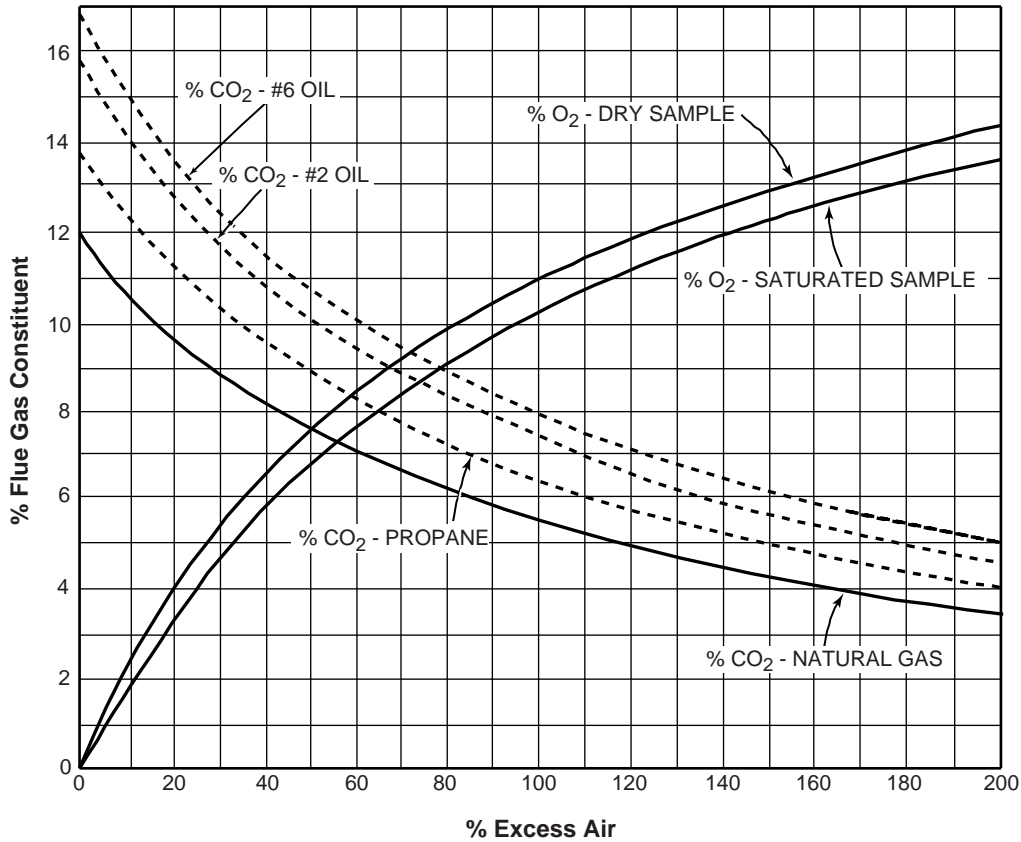

Oxygen curves are plotted for 1002 Btu/cu ft Birmingham natural gas. These curves can be used for all common fuel gases and fuel oils with no more than 0.2% error in oxygen content.

Use the “O₂ – dry sample” curve with flue gas analyzers that use dryers or condensers to remove water from the flue

gas sample. For analyzers which add water to produce a saturated sample, use the “O₂ – saturated sample” curve.

% CO₂ curves are based on typical propane and fuel oil analyses. If the fuel composition differs, actual CO₂ curves may vary slightly from those shown.

THEORETICAL FLAME TIP TEMPERATURE VS. EXCESS AIR

The maximum theoretical temperature of combustion gases at the tip of a flame decreases with increasing amounts of excess air. The curve below shows this relationship for natural gas completely burned in 60°F combustion air, but is reasonably accurate for most other common hydrocarbon fuels.

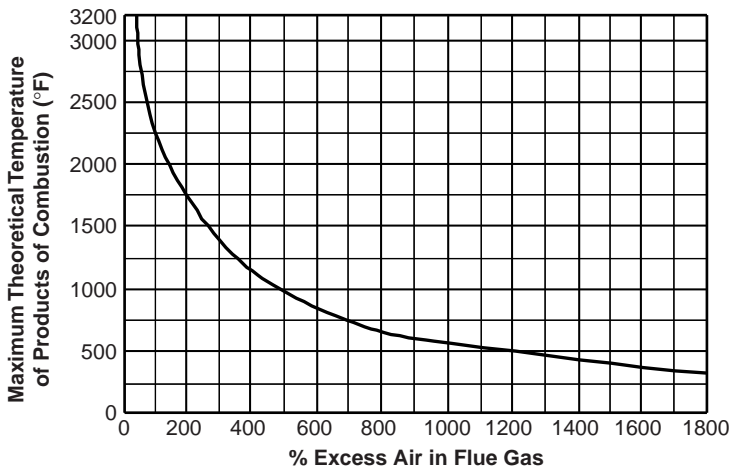

HEAT TRANSFER RELATIONSHIPS

Conduction

$$Q = \frac{kA (t_1 - t_2)}{L}$$

Convection

$$Q = fA (t_1 - t_2)$$

Radiation

$$Q = \frac{AK (T_1^4 - T_2^4)}{\frac{1}{P_1} + \frac{1}{P_2} - 1}$$

Q = heat transferred, Btu/hr

A = surface area across which heat is being transferred, sq. ft.

t₁ = temperature of heat source, °F

t₂ = temperature of heat receiver, °F

L = thickness of object through which heat is conducted

k = conductivity of material, $\frac{\text{Btu-ft}}{\text{hr-sq ft-}^\circ\text{F}}$

f = convection film coefficient, $\frac{\text{Btu-ft}}{\text{hr-sq ft-}^\circ\text{F}}$

K = Stefan-Boltzmann constant, = .1724 x 10⁻⁸ Btu/sq ft-hr-(°R)⁴

P₁ = emissivity of heat source

P₂ = emissivity of heat receiver

T₁ = temperature of heat source, °R

T₂ = temperature of heat receiver, °R (°R = °F + 460)

THERMAL HEAD & COLD AIR INFILTRATION INTO FURNACES

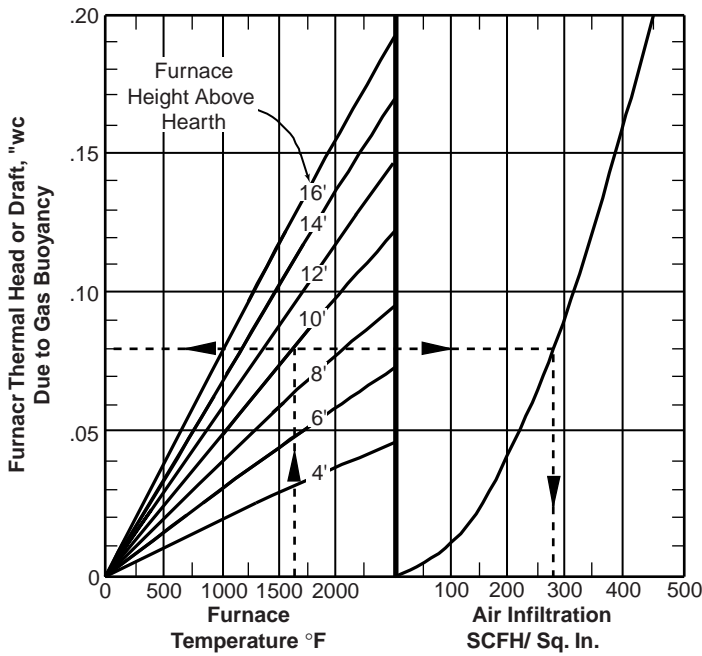

The natural buoyancy of heated gases causes them to rise and collect under the roof of a furnace or oven. This creates a natural pressure differential, called thermal head or draft, which tends to pull cold air in through furnace leaks on top-flued furnaces. These leaks are most pronounced at low fire, when burner combustion gas flow is insufficient to replace furnace gases drawn out by thermal head.

This graph can be used to predict thermal head and cold air infiltration.

Example: Determine thermal head and cold air infiltration in a 10' tall furnace operating at 1600°F.

Solution: Read up from 1600°F furnace temperature to the intersection of the 10' curve. Read to the left to find thermal head, 0.08" w.c. To determine air infiltration, read right to the infiltration curve and then down to the infiltration rate, 280 scfh per square inch.

FURNACE FLUE SIZING

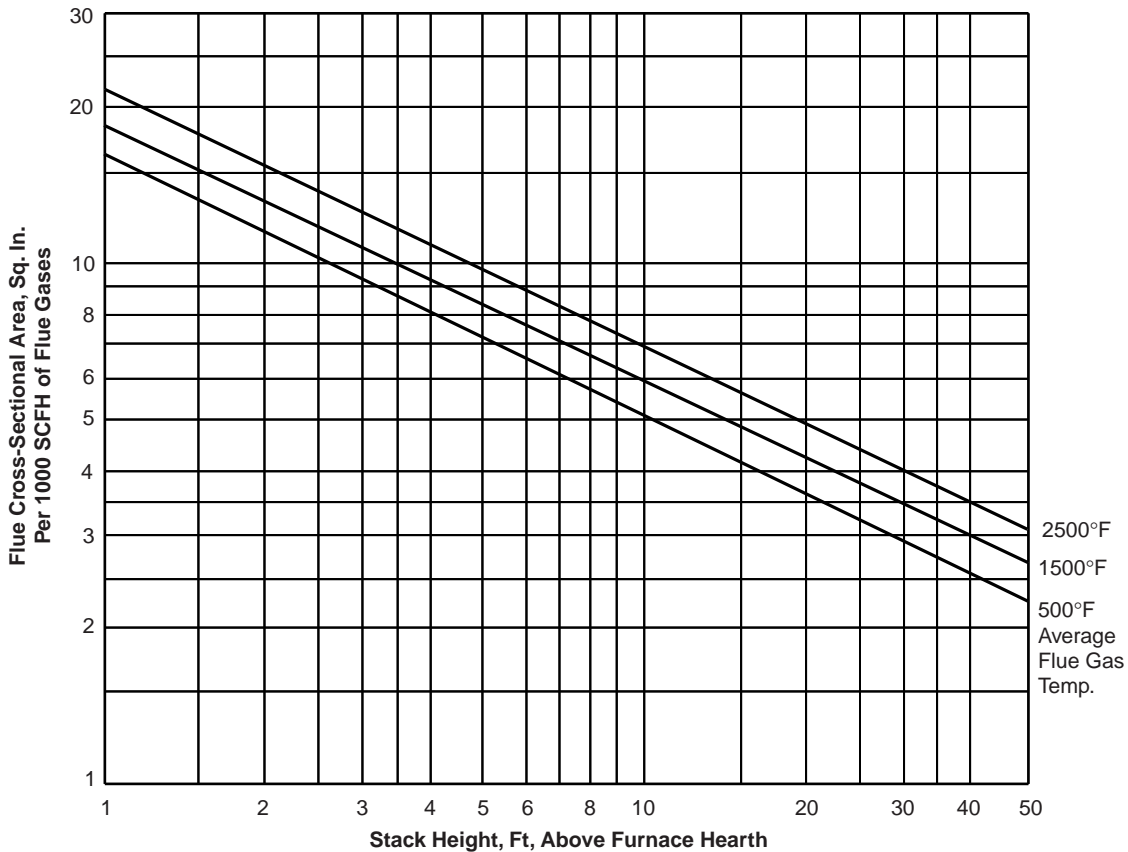

These curves predict the flue area required per 1000 scfh of flue gases, based on the average temperature of those gases and the height of the furnace stack. Flue openings are assumed to be simple orifices with a discharge coefficient of 0.6, and all pressure drop across those orifices is provided by the thermal head of the flue gases.

This method is conservative – it will produce generously sized flues.

Refer to Page 23 for volumes of combustion products for various fuels. Remember that if the combustion system is to be operated with excess air, the volume of combustion products has to be adjusted accordingly.

Average flue gas temperature will have to be estimated, taking into account the effect of stack heat losses and dilution air.

CHAPTER 9 – MECHANICAL DATA

DIMENSIONAL AND CAPACITY DATA – SCHEDULE 40 PIPE

Nominal	Diameter, Inches		Wall Thickness, Inches	Cross-Sectional Area Sq. in.			Weight Per Foot, lb.		
	Actual Inside	Actual Outside		Outside	Inside	Metal	of Pipe Alone	of Water In Pipe	of Pipe and Water
1/8	0.269	0.405	0.068	0.129	0.057	0.072	0.25	0.028	0.278
1/4	0.364	0.540	0.088	0.229	0.104	0.125	0.43	0.045	0.475
3/8	0.493	0.675	0.091	0.358	0.191	0.167	0.57	0.083	0.653
1/2	0.622	0.840	0.109	0.554	0.304	0.250	0.86	0.132	0.992
3/4	0.824	1.050	0.113	0.866	0.533	0.333	1.14	0.232	1.372
1	1.049	1.315	0.133	1.358	0.864	0.494	1.68	0.375	2.055
1-1/4	1.380	1.660	0.140	2.164	1.495	0.669	2.28	0.649	2.929
1-1/2	1.610	1.900	0.145	2.835	2.036	0.799	2.72	0.882	3.602
2	2.067	2.375	0.154	4.431	3.356	1.075	3.66	1.454	5.114
2-1/2	2.469	2.875	0.203	6.492	4.788	1.704	5.80	2.073	7.873
3	3.068	3.500	0.216	9.621	7.393	2.228	7.58	3.201	10.781
3-1/2	3.548	4.000	0.226	12.568	9.888	2.680	9.11	4.287	13.397
4	4.026	4.500	0.237	15.903	12.730	3.173	10.80	5.516	16.316
5	5.047	5.563	0.258	24.308	20.004	4.304	14.70	8.674	23.374
6	6.065	6.625	0.280	34.474	28.890	5.584	19.00	12.52	31.52
8	7.981	8.625	0.322	58.426	50.030	8.396	28.60	21.68	50.28
10	10.020	10.750	0.365	90.79	78.85	11.90	40.50	34.16	74.66
12	11.938	12.750	0.406	127.67	113.09	15.77	53.60	48.50	102.10
14	13.126	14.000	0.437	153.94	135.33	18.61	63.30	58.64	121.94
16	15.000	16.000	0.500	201.06	176.71	24.35	82.80	76.58	159.38
18	16.876	18.000	0.562	254.47	223.68	30.79	105.00	96.93	201.93
20	18.814	20.000	0.593	314.16	278.01	36.15	123.00	120.46	243.46

Nominal Dia. In.	Circumference, Inches		Sq. Ft. of Surface Per Lineal Foot		Contents of Pipe Per Lineal Foot		Lineal Feet To Contain		
	Outside	Inside	Outside	Inside	Cu. Ft.	Gal.	1 Cu. Ft.	1 Gal.	1 LB. of Water
1/8	1.27	0.84	0.106	0.070	0.0004	0.003	2533.775	338.74	35.714
1/4	1.69	1.14	0.141	0.095	0.0007	0.005	1383.789	185.00	22.222
3/8	2.12	1.55	0.177	0.129	0.0013	0.010	754.360	100.85	12.048
1/2	2.65	1.95	0.221	0.167	0.0021	0.016	473.906	63.36	7.576
3/4	3.29	2.58	0.275	0.215	0.0037	0.028	270.034	36.10	4.310
1	4.13	3.29	0.344	0.274	0.0062	0.045	166.618	22.28	2.667
1-1/4	5.21	4.33	0.435	0.361	0.0104	0.077	96.275	12.87	1.541
1-1/2	5.96	5.06	0.497	0.422	0.0141	0.106	70.733	9.46	1.134
2	7.46	6.49	0.622	0.540	0.0233	0.174	42.913	5.74	0.688
2-1/2	9.03	7.75	0.753	0.654	0.0332	0.248	30.077	4.02	0.482
3	10.96	9.63	0.916	0.803	0.0514	0.383	19.479	2.60	0.312
3-1/2	12.56	11.14	1.047	0.928	0.0682	0.513	14.565	1.95	0.233
4	14.13	12.64	1.178	1.052	0.0884	0.660	11.312	1.51	0.181
5	17.47	15.84	1.456	1.319	0.1390	1.040	7.198	0.96	0.115
6	20.81	19.05	1.734	1.585	0.2010	1.500	4.984	0.67	0.080
8	27.09	26.07	2.258	2.090	0.3480	2.600	2.878	0.38	0.046
10	33.77	31.47	2.814	2.622	0.5470	4.100	1.826	0.24	0.029
12	40.05	37.70	3.370	3.140	0.7850	5.870	1.273	0.17	0.021
14	47.12	44.76	3.930	3.722	1.0690	7.030	1.067	0.14	0.017
16	53.41	51.52	4.440	4.310	1.3920	9.180	0.814	0.11	0.013
18	56.55	53.00	4.712	4.420	1.5530	11.120	0.644	0.09	0.010
20	62.83	59.09	5.236	4.920	1.9250	14.400	0.517	0.07	0.008

DIMENSIONS OF MALLEABLE IRON THREADED FITTINGS

per ANSI B 16.3-1977

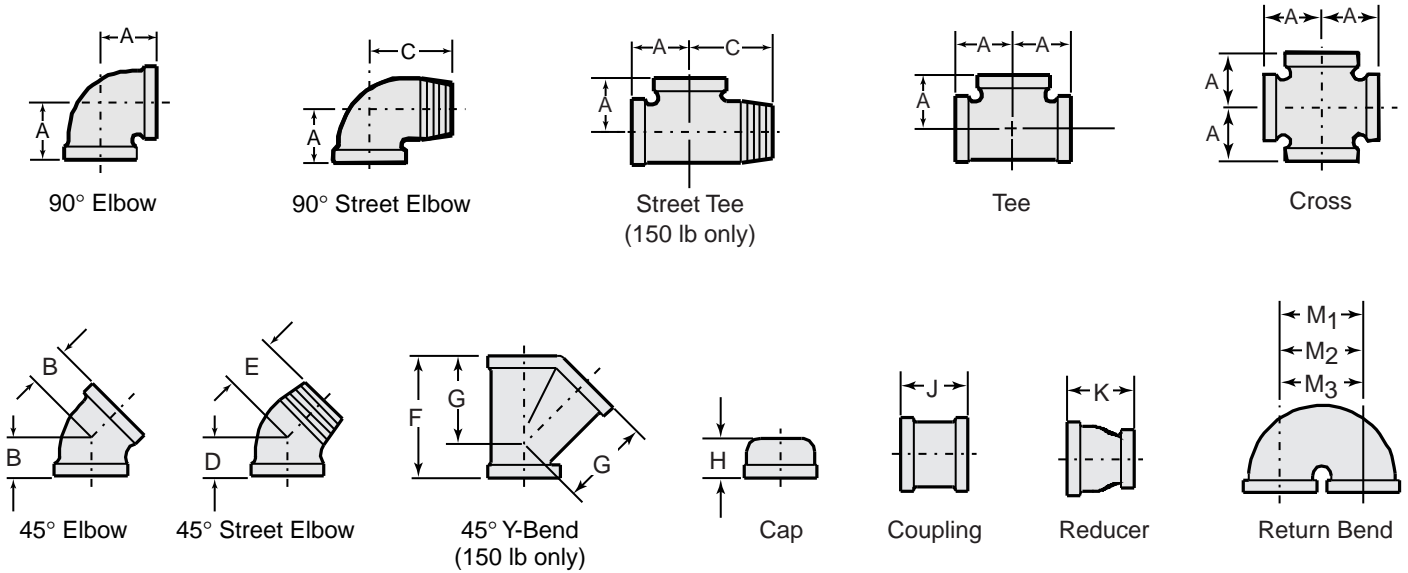

CLASS 150 FITTINGS

Size	Thread Engagement	A	B	C	D	E	F	G	H	J	K	M ₁ Close Pattern	M ₂ Med. Pattern	M ₃ Open Pattern
1/8	0.25	0.69	—	1.00	—	—	—	—	0.53	0.96	—	—	—	—
1/4	0.32	0.81	0.73	1.19	0.73	0.94	—	—	0.63	1.06	1.00	—	—	—
3/8	0.36	0.95	0.80	1.44	0.80	1.03	1.93	1.43	0.74	1.16	1.13	—	—	—
1/2	0.43	1.12	0.88	1.63	0.88	1.15	2.32	1.71	0.87	1.34	1.25	1.00	1.25	1.50
3/4	0.50	1.31	0.98	1.89	0.98	1.29	2.77	2.05	0.97	1.52	1.44	1.25	1.50	2.00
1	0.58	1.50	1.12	2.14	1.12	1.47	3.28	2.43	1.16	1.67	1.69	1.50	1.87	2.50
1-1/4	0.67	1.75	1.29	2.45	1.29	1.71	3.94	2.92	1.28	1.93	2.06	1.75	2.25	3.00
1-1/2	0.70	1.94	1.43	2.69	1.43	1.88	4.38	3.28	1.33	2.15	2.31	2.19	2.50	3.50
2	0.75	2.25	1.68	3.26	1.68	2.22	5.17	3.93	1.45	2.53	2.81	2.62	3.00	4.00
2-1/2	0.92	2.70	1.95	3.86	1.95	2.57	6.25	4.73	1.70	2.88	3.25	—	—	4.50
3	0.98	3.08	2.17	4.51	2.17	3.00	7.26	5.55	1.80	3.18	3.69	—	—	5.00
3-1/2	1.03	3.42	2.39	—	—	—	—	—	1.90	—	—	—	—	—
4	1.08	3.79	2.61	5.69	2.61	3.70	8.98	6.97	2.08	3.69	4.38	—	—	6.00
5	1.18	4.50	3.05	6.86	—	—	—	—	2.32	—	—	—	—	—
6	1.28	5.13	3.46	8.03	—	—	—	—	2.55	—	—	—	—	—

CLASS 300 FITTINGS

Size	Thread Engagement	A	B	C	D	E	H	J	K	M ₁	M ₂	M ₃
1/4	0.43	0.94	0.81	1.44	—	—	0.78	1.37	—	—	—	—
3/8	0.47	1.06	0.88	1.63	—	—	0.83	1.62	1.44	—	—	—
1/2	0.57	1.25	1.00	2.00	1.00	1.38	0.98	1.87	1.69	—	—	—
3/4	0.64	1.44	1.13	2.19	1.13	1.56	1.08	2.12	1.75	—	—	—
1	0.75	1.63	1.31	2.56	1.31	1.81	1.26	2.37	2.00	1.75	2.50	3.00
1-1/4	0.84	1.94	1.50	2.88	1.50	2.13	1.38	2.87	2.38	2.25	2.50	3.00
1-1/2	0.87	2.13	1.69	3.13	1.69	2.31	1.43	2.87	2.69	3.00	3.50	6.00
2	1.00	2.50	2.00	3.69	2.00	2.69	1.68	3.62	3.19	4.00	6.00	8.00
2-1/2	1.17	2.94	2.25	4.50	—	—	2.06	4.12	3.69	—	—	—
3	1.23	3.38	2.50	5.13	—	—	2.17	4.12	4.06	—	—	—

SHEET METAL GAUGES & WEIGHTS

Gauge No.	Carbon Steel		Galvanized Steel		Stainless (Cr-Ni) Steel	
	Thickness, in.	lb. per sq. ft.	Thickness, in.	lb per sq. ft	Thickness, in.	lb. per sq. ft.
7	.1793	7.500	—	—	—	—
8	.1644	6.875	.1681	7.031	.165	6.930
9	.1495	6.250	.1532	6.406	.1563	6.563
10	.1345	5.625	.1382	5.781	.135	5.670
11	.1196	5.000	.1233	5.156	.120	5.040
12	.1096	4.375	.1084	4.531	.1054	4.427
13	.0897	3.750	.0934	3.906	.090	3.780
14	.0747	3.125	.0785	3.281	.0751	3.154
15	.0673	2.812	.0710	2.969	.0703	2.953
16	.0598	2.500	.0635	2.656	.0595	2.499
17	.0538	2.250	.0575	2.406	.0563	2.363
18	.0478	2.000	.0516	2.156	.048	2.016
19	.0418	1.750	.0456	1.906	.042	1.764
20	.0359	1.500	.0396	1.656	.0355	1.491
21	.0329	1.375	.0366	1.531	.0344	1.444
22	.0299	1.250	.0336	1.406	.0293	1.231
23	.0269	1.125	.0306	1.281	.0281	1.181
24	.0239	1.000	.0276	1.156	.0235	.987
25	.0209	.875	.0247	1.031	.0219	.919
26	.0179	.750	.0217	.906	.0178	.748
27	.0164	.688	.0202	.844	.0172	.722
28	.0149	.625	.0187	.781	.0151	.634
29	.0135	.563	.0172	.719	—	—
30	.0120	.500	.0157	.656	—	—

SHEET WIRE GAUGES & WEIGHTS

Gauge No.	Diameter, inches			Gauge No.	Diameter, inches		
	AWG ¹	Steel Wire Gauge ²	BWG ³		AWG ¹	Steel Wire Gauge ²	BWG ³
0	.3249	.3065	.340	15	.0571	.0720	.072
1	.2893	.2830	.300	16	.0508	.0625	.065
2	.2576	.2625	.284	17	.0453	.0540	.058
3	.2294	.2437	.259	18	.0403	.0475	.049
4	.2043	.2253	.238	19	.0359	.0410	.042
5	.1819	.2070	.220	20	.0320	.0348	.035
6	.1620	.1920	.203	21	.0285	.0317	.032
7	.1443	.1770	.180	22	.0253	.0286	.028
8	.1285	.1620	.165	23	.0226	.0258	.025
9	.1144	.1483	.148	24	.0201	.0230	.022
10	.1019	.1350	.134	25	.0179	.0204	.020
11	.0907	.1205	.120	26	.0159	.0181	.018
12	.0808	.1055	.109	27	.0142	.0173	.016
13	.0720	.0915	.095	28	.0126	.0162	.014
14	.0641	.0800	.083	29	.0113	.0150	.013
				30	.0100	.0140	.012

¹ American Wire Gauge or Brown & Sharpe Gauge for non-ferrous wire, including electrical wire.

² Or Washburn & Moen Gauge.

³ Birmingham Wire Gauge or Stubs Gauge.

CIRCUMFERENCES AND AREAS OF CIRCLES

In Inches

<u>Dia.</u>	<u>Circum.</u>	<u>Area</u>	<u>Dia.</u>	<u>Circum.</u>	<u>Area</u>	<u>Dia.</u>	<u>Circum.</u>	<u>Area</u>
1/64	.04909	.00019	3	9.4248	7.0686	8	25.133	50.265
1/32	.09818	.00077	1/16	9.6211	7.3662	1/8	25.525	51.849
3/64	.14726	.00173	1/8	9.8175	7.6699	1/4	25.918	53.456
1/16	.19635	.00307	3/16	10.014	7.9798	3/8	26.311	55.088
3/32	.29452	.00690	1/4	10.210	8.2958	1/2	26.704	56.745
1/8	.39270	.01227	5/16	10.407	8.6179	5/8	27.096	58.426
5/32	.49087	.01917	3/8	10.603	8.9462	3/4	27.489	60.132
3/16	.58905	.02761	7/16	10.799	9.2806	7/8	27.882	61.862
7/32	.68722	.03758	1/2	10.996	9.6211	9	28.274	63.617
1/4	.78540	.04909	9/16	11.192	9.9678	1/8	28.667	65.397
9/32	.88357	.06213	5/8	11.388	10.321	1/4	29.060	67.201
5/16	.98175	.07670	11/16	11.585	10.680	3/8	29.452	69.029
11/32	1.0799	.09281	3/4	11.781	11.045	1/2	29.845	70.882
3/8	1.1781	.11045	13/16	11.977	11.416	5/8	30.238	72.760
13/32	1.2763	.12962	7/8	12.174	11.793	3/4	30.631	74.662
7/16	1.3744	.15033	15/16	12.370	12.177	7/8	31.023	76.589
15/32	1.4726	.17257	4	12.566	12.566	10	31.416	78.540
1/2	1.5708	.19635	1/16	12.763	12.962	1/8	31.809	80.516
17/32	1.6690	.22166	1/8	12.959	13.364	1/4	32.201	82.516
9/16	1.7671	.24850	3/16	13.155	13.772	3/8	32.594	84.541
19/32	1.8653	.27688	1/4	13.352	14.186	1/2	32.987	86.590
5/8	1.9635	.30680	5/16	13.548	14.607	5/8	33.379	88.664
21/32	2.0617	.33824	3/8	13.744	15.033	3/4	33.772	90.763
11/16	2.1598	.37122	7/16	13.941	15.466	7/8	34.165	92.886
23/32	2.2580	.40574	1/2	14.137	15.904	11	34.558	95.033
3/4	2.3562	.44179	9/16	14.334	16.349	1/8	34.950	97.205
25/32	2.4544	.47937	5/8	14.530	16.800	1/4	35.343	99.402
13/16	2.5525	.51849	11/16	14.726	17.257	3/8	35.736	101.62
27/32	2.6507	.55914	3/4	14.923	17.721	1/2	36.128	103.87
7/8	2.7489	.60132	13/16	15.119	18.190	5/8	36.521	106.14
29/32	2.8471	.64504	7/8	15.315	18.665	3/4	36.914	108.43
15/16	2.9452	.69029	15/16	15.512	19.147	7/8	37.306	110.75
31/32	3.0434	.73708	5	15.708	19.635	12	37.699	113.10
1	3.1416	.7854	1/16	15.904	20.129	1/8	38.092	115.47
1/16	3.3379	.8866	1/8	16.101	20.629	1/4	38.485	117.86
1/8	3.5343	.9940	3/16	16.297	21.135	3/8	38.877	120.28
3/16	3.7306	1.1075	1/4	16.493	21.648	1/2	39.270	122.72
1/4	3.9270	1.2272	5/16	16.690	22.166	5/8	39.663	125.19
5/16	4.1233	1.3530	3/8	16.886	22.691	3/4	40.055	127.68
3/8	4.3197	1.4849	7/16	17.082	23.221	7/8	40.448	130.19
7/16	4.5160	1.6230	1/2	17.279	23.758	13	40.841	132.73
1/2	4.7124	1.7671	9/16	17.475	24.301	1/8	41.233	135.30
9/16	4.9087	1.9175	5/8	17.671	24.850	1/4	41.626	137.89
5/8	5.1051	2.0739	11/16	17.868	25.406	3/8	42.019	140.50
11/16	5.3014	2.2365	3/4	18.064	25.967	1/2	42.412	143.14
3/4	5.4978	2.4053	13/16	18.261	26.535	5/8	42.804	145.80
13/16	5.6941	2.5802	7/8	18.457	27.109	3/4	43.197	148.49
7/8	5.8905	2.7612	15/16	18.653	27.688	7/8	43.590	151.20
15/16	6.0868	2.9483	6	18.850	28.274	14	43.982	153.94
2	6.2832	3.1416	1/8	19.242	29.465	1/8	44.374	156.70
1/16	6.4795	3.3410	1/4	19.635	30.680	1/4	44.768	159.48
1/8	6.6759	3.5466	3/8	20.028	31.919	3/8	45.160	162.30
3/16	6.8722	3.7583	1/2	20.420	33.183	1/2	45.553	165.13
1/4	7.0686	3.9761	5/8	20.813	34.472	5/8	45.946	167.99
5/16	7.2649	4.2000	3/4	21.206	35.785	3/4	46.338	170.87
3/8	7.4613	4.4301	7/8	21.598	37.122	7/8	46.731	173.78
7/16	7.6576	4.6664	7	21.991	38.485	15	47.124	176.71
1/2	7.8540	4.9087	1/8	22.384	39.871	1/8	47.517	179.67
9/16	8.0503	5.1572	1/4	22.776	41.282	1/4	47.909	182.65
5/8	8.2467	5.4119	3/8	23.169	42.718	3/8	48.302	185.66
11/16	8.4430	5.6727	1/2	23.562	44.179	1/2	48.695	188.69
3/4	8.6394	5.9396	5/8	23.955	45.664	5/8	49.087	191.75
13/16	8.8357	6.2126	3/4	24.347	47.173	3/4	49.480	194.83
7/8	9.0321	6.4918	7/8	24.740	48.707	7/8	49.873	197.93
15/16	9.2284	6.7771						

CIRCUMFERENCES AND AREAS OF CIRCLES (Cont'd) In Inches

<u>Dia.</u>	<u>Circum.</u>	<u>Area</u>	<u>Dia.</u>	<u>Circum.</u>	<u>Area</u>	<u>Dia.</u>	<u>Circum.</u>	<u>Area</u>
16	50.265	201.06	24	75.398	452.39	39	122.522	1194.6
1/8	50.658	204.22	1/8	75.791	457.11	40	125.664	1256.6
1/4	51.051	207.39	1/4	76.184	461.86	41	128.805	1320.3
3/8	51.444	210.60	3/8	76.576	466.64	42	131.947	1385.4
1/2	51.836	213.82	1/2	76.969	471.44	43	135.088	1452.2
5/8	52.229	217.08	5/8	77.362	476.26	44	138.230	1520.5
3/4	52.622	220.35	3/4	77.754	481.11	45	141.372	1590.4
7/8	53.014	223.65	7/8	78.147	485.98	46	144.513	1661.9
17	53.407	226.98	25	78.540	490.87	47	147.655	1734.9
1/8	53.800	230.33	1/8	78.933	495.79	48	150.796	1809.6
1/4	54.192	233.71	1/4	79.325	500.74	49	153.939	1885.7
3/8	54.585	237.10	3/8	79.718	505.71	50	157.080	1963.5
1/2	54.978	240.53	1/2	80.111	510.71	51	160.221	2042.8
5/8	55.371	243.98	5/8	80.503	515.72	52	163.363	2123.7
3/4	55.763	247.45	3/4	80.896	520.77	53	166.504	2206.2
7/8	56.156	250.95	7/8	81.289	525.84	54	169.646	2290.2
18	56.549	254.47	26	81.681	530.93	55	172.788	2375.8
1/8	56.941	258.02	1/8	82.074	536.05	56	175.929	2463.0
1/4	57.334	261.59	1/4	82.467	541.19	57	179.071	2551.8
3/8	57.727	265.18	3/8	82.860	546.35	58	182.212	2642.1
1/2	58.119	268.80	1/2	83.252	551.55	59	185.354	2734.0
5/8	58.512	272.45	5/8	83.645	556.76	60	188.496	2827.4
3/4	58.905	276.12	3/4	84.038	562.00	61	191.637	2922.5
7/8	59.298	279.81	7/8	84.430	567.27	62	194.779	3019.1
19	59.690	283.53	27	84.823	572.56	63	197.920	3117.2
1/8	60.083	287.27	1/8	85.216	577.87	64	201.062	3217.0
1/4	60.476	291.04	1/4	85.608	583.21	65	204.204	3318.3
3/8	60.868	294.83	3/8	86.001	588.57	66	207.345	3421.2
1/2	61.261	298.65	1/2	86.394	593.96	67	210.487	3525.7
5/8	61.654	302.49	5/8	86.786	599.37	68	213.628	3631.7
3/4	62.046	306.35	3/4	87.179	604.81	69	216.770	3739.3
7/8	62.439	310.24	7/8	87.572	610.27	70	219.911	3848.5
20	62.832	314.16	28	87.965	615.75	71	223.053	3959.2
1/8	63.225	318.10	1/8	88.357	621.26	72	226.195	4071.5
1/4	63.617	322.06	1/4	88.750	626.80	73	229.336	4185.4
3/8	64.010	326.05	3/8	89.143	632.36	74	232.478	4300.8
1/2	64.403	330.06	1/2	89.535	637.94	75	235.619	4417.9
5/8	64.795	334.10	5/8	89.928	643.55	76	238.761	4536.6
3/4	65.188	338.16	3/4	90.321	649.18	77	241.903	4656.6
7/8	65.581	342.25	7/8	90.713	654.84	78	245.044	4778.4
21	65.973	346.36	29	91.106	660.52	79	248.186	4901.7
1/8	66.366	350.50	1/8	91.499	666.23	80	251.327	5026.5
1/4	66.759	354.66	1/4	91.892	671.96	81	254.469	5153.0
3/8	67.152	358.84	3/8	92.284	677.71	82	257.611	5281.0
1/2	67.544	363.05	1/2	92.677	683.49	83	260.752	5410.6
5/8	67.937	367.28	5/8	93.070	689.30	84	263.894	5541.8
3/4	68.330	371.54	3/4	93.462	695.13	85	267.035	5674.5
7/8	68.722	375.83	7/8	93.855	700.98	86	270.177	5808.8
22	69.115	380.13	30	94.248	706.86	87	273.319	5944.7
1/8	69.508	384.46	1/8	94.640	712.76	88	276.460	6082.1
1/4	69.900	388.82	1/4	95.033	718.69	89	279.602	6221.1
3/8	70.293	393.20	3/8	95.426	724.64	90	282.743	6361.7
1/2	70.686	397.61	1/2	95.819	730.62	91	285.885	6503.9
5/8	71.079	402.04	5/8	96.211	736.62	92	289.027	6647.6
3/4	71.471	406.49	3/4	96.604	742.64	93	292.168	6792.9
7/8	71.864	410.97	7/8	96.997	748.69	94	295.310	6939.8
23	72.257	415.48	31	97.389	754.77	95	298.451	7088.2
1/8	72.649	420.00	32	100.531	804.25	96	301.593	7238.2
1/4	73.042	424.56	33	103.673	855.30	97	304.734	7389.8
3/8	73.435	429.13	34	106.814	907.92	98	307.876	7543.0
1/2	73.827	433.74	35	109.956	962.11	99	311.018	7697.7
5/8	74.220	438.36	36	113.097	1017.9	100	314.159	7854.0
3/4	74.613	443.01	37	116.239	1075.2			
7/8	75.006	447.69	38	119.381	1134.1			

DRILL SIZE DATA

<u>Twist Drill Size</u>	<u>Dia. In.</u>	<u>Area Sq. In.</u>	<u>Twist Drill Size</u>	<u>Dia. In.</u>	<u>Area Sq. In.</u>	<u>Twist Drill Size</u>	<u>Dia. In.</u>	<u>Area Sq. In.</u>			
-	80	.0135	.000143	-	32	.116	.0106	19/64	-	.2968	.0692
-	79	.0145	.000165	-	31	.120	.0113	-	N	.302	.0716
1/64	-	.0156	.00019	1/8	-	.125	.0123	5/16	-	.3125	.0767
-	78	.016	.00020	-	30	.1285	.0130	-	O	.316	.0784
-	77	.018	.00025	-	29	.136	.0145	-	P	.323	.0820
-	76	.020	.00031	-	28	.1405	.0155	21/64	-	.3281	.0846
-	75	.021	.00035	9/64	-	.1406	.0156	-	Q	.332	.0866
-	74	.0225	.00040	-	27	.144	.0163	-	R	.339	.0901
-	73	.024	.00045	-	26	.147	.0174	11/32	-	.3437	.0928
-	72	.025	.00049	-	25	.1495	.0175	-	S	.348	.0950
-	71	.026	.00053	-	24	.152	.0181	-	T	.358	.1005
-	70	.028	.00062	-	23	.154	.0186	23/64	-	.3593	.1014
-	69	.0292	.00067	5/32	-	.1562	.0192	-	U	.368	.1063
-	68	.030	.00075	-	22	.157	.0193	3/8	-	.375	.1104
1/32	-	.0312	.00076	-	21	.159	.0198	-	V	.377	.1116
-	67	.032	.00080	-	20	.161	.0203	-	W	.386	.1170
-	66	.033	.00086	-	19	.166	.0216	25/64	-	.3906	.1198
-	65	.035	.00096	-	18	.1695	.0226	-	X	.397	.1236
-	64	.036	.00102	11/64	-	.1719	.0232	-	Y	.404	.1278
-	63	.037	.00108	-	17	.175	.0235	13/32	-	.4062	.1296
-	62	.038	.00113	-	16	.177	.0246	-	Z	.413	.1340
-	61	.039	.00119	-	15	.180	.0254	7/16	-	.4375	.1503
-	60	.040	.00126	-	14	.182	.0260	29/64	-	.4531	.1613
-	59	.041	.00132	-	13	.185	.0269	15/32	-	.4687	.1726
-	58	.042	.00138	3/16	-	.1875	.0276	31/64	-	.4843	.1843
-	57	.043	.00145	-	12	.189	.02805	1/2	-	.5000	.1963
-	56	.0465	.00170	-	11	.191	.02865	33/64	-	.5156	.2088
3/64	-	.0469	.00173	-	10	.1935	.0294	17/32	-	.5312	.2217
-	55	.0520	.00210	-	9	.196	.0302	35/64	-	.5468	.2349
-	54	.0550	.0023	-	8	.199	.0311	9/16	-	.5625	.2485
-	53	.0595	.0028	-	7	.201	.0316	37/64	-	.5781	.2625
1/16	-	.0625	.0031	13/64	-	.2031	.0324	19/32	-	.5937	.2769
-	52	.0635	.0032	-	6	.204	.0327	39/64	-	.6093	.2916
-	51	.0670	.0035	-	5	.2055	.0332	5/8	-	.625	.3068
-	50	.070	.0038	-	4	.209	.0343	41/64	-	.6406	.3223
-	49	.073	.0042	-	3	.213	.0356	21/32	-	.6562	.3382
-	48	.076	.0043	7/32	-	.2187	.0376	43/64	-	.6718	.3545
5/64	-	.0781	.0048	-	2	.221	.0384	11/16	-	.6875	.3712
-	47	.0785	.0049	-	1	.228	.0409	45/64	-	.7031	.3883
-	46	.081	.0051	-	A	.234	.0430	23/32	-	.7187	.4057
-	45	.082	.0053	15/64	-	.2343	.0431	47/64	-	.7343	.4236
-	44	.086	.0058	-	B	.238	.0444	3/4	-	.750	.4418
-	43	.089	.0062	-	C	.242	.0460	49/64	-	.7656	.4604
-	42	.0935	.0069	-	D	.246	.0475	25/32	-	.7812	.4794
3/32	-	.0937	.0069	1/4	E	.250	.0491	51/64	-	.7968	.4987
-	41	.096	.0072	-	F	.257	.0519	13/16	-	.8125	.5185
-	40	.098	.0075	-	G	.261	.0535	53/64	-	.8281	.5386
-	39	.0995	.0078	17/64	-	.2656	.0554	27/32	-	.8337	.5591
-	38	.1015	.0081	-	H	.266	.0556	55/64	-	.8593	.5800
-	37	.104	.0085	-	I	.272	.0580	7/8	-	.875	.6013
-	36	.1065	.0090	-	J	.277	.0601				
7/64	-	.1093	.0094	-	K	.281	.0620				
-	35	.110	.0095	9/32	-	.2812	.0621				
-	34	.111	.0097	-	L	.290	.0660				
-	33	.113	.0100	-	M	.295	.0683				

TAP DRILL SIZES

Taps for Machine Threads – Drill sizes for 75% of full thread

Thread Size	Tap Drill Size	Thread Size	Tap Drill Size
6-32 NC	36	3/8-16 NC	5/16
6-40 NF	34	3/8-24 NF	Q
8-32 NC	30	7/16-14 NC	U
8-36 NF	29	7/16-20 NF	W
10-24 NC	25	1/2-13 NC	.425
10-32 NF	21	1/2-20 NF	29/64
12-24 NC	17	9/16-12 NC	31/64
12-28 NF	15	9/16-18 NF	.508
1/4-20 NC	7	5/8-11 NC	17/32
1/4-28 NF	3	5/8-18 NF	.571
5/16-18 NC	F	3/4-10 NC	21/32
5/16-24 NF	I	3/4-16 NF	11/16
		7/8-9 NC	49/64
		7/8-14 NF	.805
		1-8 NC	7/8

Pipe Taps – American Standard and Dryseal Pipe Threads

Pipe Size, Inches	Threads Per Inch	Tap Drill Size	Pipe Size Inches	Threads Per Inch	Tap Drill Size
1/8	27	11/32	2	11-1/2	2-7/32
1/4	18	7/16	2-1/2	8	2-5/8
3/8	18	9/16	3	8	3-1/4
1/2	14	45/64	4	8	4-1/4
3/4	14	29/32	5	8	5-5/16
1	11-1/2	1-9/64	6	8	6-3/8
1-1/4	11-1/2	1-31/64	8	8	8-3/8
1-1/2	11-1/2	1-47/64			

See page 59 for diameters of numbered and lettered tap drills.

DRILLING TEMPLATES – PIPE FLANGES

Drilling template dimensions of Class 150 pipe flanges per ANSI B 16.5 – 1981.

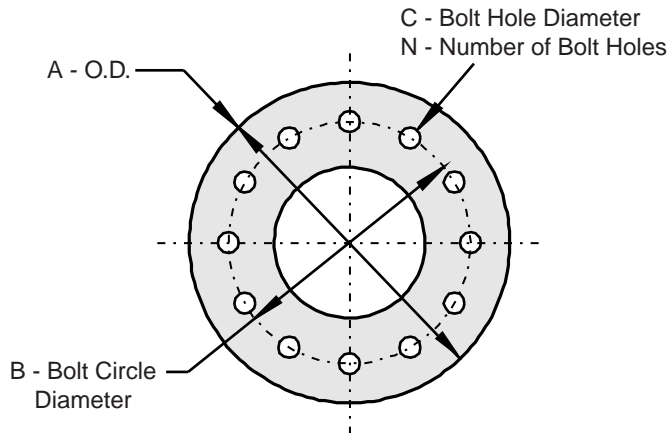

Nominal Pipe Size	All dimensions in inches				Bolt Diameter
	A	B	C	N	
1/2	3.50	2.38	.62	4	1/2
3/4	3.88	2.75	.62	4	1/2
1	4.25	3.12	.62	4	1/2
1-1/4	4.62	3.50	.62	4	1/2
1-1/2	5.00	3.88	.62	4	1/2
2	6.00	4.75	.75	4	5/8
2-1/2	7.00	5.50	.75	4	5/8
3	7.50	6.00	.75	4	5/8
4	9.00	7.50	.75	8	5/8
6	11.00	9.50	.88	8	3/4
8	13.50	11.75	.88	8	3/4
10	16.00	14.25	1.00	12	7/8
12	19.00	17.00	1.00	12	7/8
14	21.00	18.75	1.12	12	1
16	23.50	21.25	1.12	16	1
18	25.00	22.75	1.25	16	1-1/8
20	27.50	25.00	1.25	20	1-1/8
24	32.00	29.50	1.38	20	1-1/4

CHAPTER 10 – ABBREVIATIONS & SYMBOLS

ABBREVIATIONS











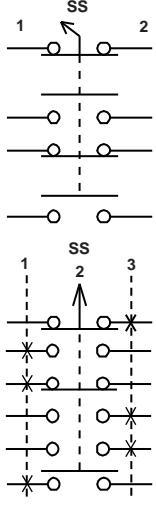

A – ampere(s), area	in³ – cubic inch(es)
A, C, or a-c – alternating current	JIC – Joint Industrial Council
acfh – actual cubic feet per hour	K – Stefan – Boltzmann constant
acfm – actual cubic feet per minute	k – thermal conductivity
ANSI – American National Standards Institute	°K – degrees Kelvin
API – American Petroleum Institute	kcal – kilogram-calorie or kilo-calorie (same as Cal)
°API – degrees API (a measurement of fuel oil specific gravity)	kPa – kiloPascal
ASTM – American Society for Testing and Materials	kVA – kilo volt – amperes
AWG – American Wire Gauge	L – length or thickness
Btu – British thermal unit	lb – pound(s)
BWG – Birmingham Wire Gauge	LPG – liquified petroleum gas
C or °C – degrees Celsius or Centigrade	mbar – millibar(s)
Cal – kilogram-calorie or kilo-calorie (equals 1000 calories)	mmHg – millimeters of mercury column
cal – calorie	mmw.c. – millimeters of water column
Cd – coefficient of discharge	N.C. – normally closed
cfh – cubic feet per hour	NEMA – National Electrical Manufacturers Association
cfm – cubic feet per minute	NFPA – National Fire Protection Association
CL – centerline	N.O. – normally open
cm – centimeter(s)	OD or od – outside diameter
cs or cSt – centistoke(s)	osi – ounces per square inch
cu ft – cubic feet	oz – ounce(s)
cu in – cubic inches	P – pressure or pressure drop
cu m – cubic meters	psi – pounds per square inch
C_v - flow coefficient or flow factor (for valve capacities)	psia – pounds per square inch, absolute
D or d – density, diameter	psig – pounds per square inch, gauge
D.C. or d-c – direct current	Pv – velocity pressure
deg – degree(s)	Q – flow (of gases, liquids, or heat)
dia – diameter	°R – degrees Rankine
e - emissivity	rpm – revolutions per minute
°E – degrees Engler (a measurement of fuel oil viscosity)	scfh – standard cubic feet per hour
F or °F – degrees Fahrenheit	scfm – standard cubic feet per minute
f – convection film coefficient	sec – second
F.B. – firebrick	S.G. or sg – specific gravity
fpm – feet per minute	sp ht – specific heat
fps – feet per second	sp gr – specific gravity
ft – foot or feet	sq ft – square feet
G or g – gravity or specific gravity	sq in – square inch(es)
gal – gallon(s)	SR1 – seconds Redwood #1 (a measurement of fuel oil viscosity)
gph – gallons per hour	SSF – seconds Saybolt Furol (a measurement of fuel oil viscosity)
gpm – gallons per minute	SSU – seconds Saybolt Universal (a measurement of fuel oil viscosity)
h - pressure drop	T or t – temperature
h_f – heat content of liquid (water & steam)	T_{abs} – absolute temperature
h_{fg} – latent heat of vaporization, water to steam	TC – cold face temperature or thermocouple
h_g – heat content of vapor (steam)	V – vacuum, volts, or volume
"Hg – inches of mercury column	V_g – specific volume of water vapor
HL – heat loss	W – flow rate
HP or hp – horsepower	"w.c. – inches of water column
hr – hour(s)	"w.g. – inches of water gauge (same as "w.c.)
HS – heat storage	wt – weight
Hz – Hertz (cycles per second in alternating current)	
ID or id – inside diameter	
I.F.B. – insulating firebrick	
in – inch(es)	
in² – square inch(es)	

ELECTRICAL SYMBOLS

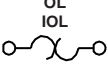
Shown below are graphic symbols commonly used in JIC-type ladder diagrams for combustion control systems. For a complete list of symbols, refer to JIC Electrical Standard EMP-1.

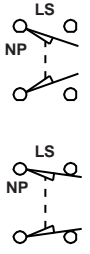
Description	Symbol	Description	Symbol	Description	Symbol
Coils -Relays (CR) -Timers (TR) - Motor Starters (M) - Contactors (CON)		Contacts - Relays (CR) - Motor Starters (M) - Contactors (CON) - N.O.		Pilot Light (Letter denotes color)	
Coils -Solenoids		- N.C.		Pilot Light- Push to Test (Letter denotes color)	
Conductors -Not Connected		Contacts -Thermal Overload -Overload Relay (OL) -Instantaneous Overload (IOL)		Pushbutton -Single Circuit, N.O. -Single Circuit, N.C.	
-Connected				-Double Circuit	
Connections -Ground		Control Circuit Transformer		-Double Circuit, Mushroom Head	
-Chassis or Frame (not necessarily grounded)		Fuses - All Types		-Maintained Contact	
-Plug and Receptacle		Horn or Siren (Alarm)			
Contacts -Time Delay After Coil Energized -N.O.		Meters -Volt		Switches - Disconnect	
-N.C.		-Amp		- Circuit Interruptor	
-Time Delay After Coil De-energized -N.O.		Motors -3 Phase		- Circuit Breaker	
-N.C.		-D.C.			
		Potentiometer			

ELECTRICAL SYMBOLS (Cont'd)

Description	Symbol	Description	Symbol	Description	Symbol				
Switch, Limit — N.O.		Switch, Selector — 2 Position — 3 Position		Switch, Vacuum or Pressure — N.O.					
— Held Closed					— N.C.				
— N.C.				Switch, Temperature — N.O. — N.C.		Thermal Overload Element — Overload (OL) — Instantaneous Overload (IOL)			
— Held Open								Thermocouple	
— Neutral Position, — Neutral Position, Actuated									
Switch, Liquid Level — N.O.								Switch, Toggle	
— N.C.									

CHAPTER 11 – CONVERSION FACTORS

GENERAL CONVERSION FACTORS

MULTIPLY	BY	TO OBTAIN	MULTIPLY	BY	TO OBTAIN
atmospheres	33.90	Feet of H ₂ O	circular mils	.00000507	.sq.cm.
	29.92	Inches of Hg		.785	.sq.mils
	14.70	Psi		.000000785	.sq. inches
	1013.2	Millibars	cubic centimeters	.00000353	.cubic ft.
	760.0	mm. of Hg		.061	.cubic in.
	1.058	Tons/sq.ft		.000001	.cubic meters
	1.033	.Kg./sq. cm.		.00000131	.cubic yards
barrels (oil)	.42	Gallons (oil)		.000264	gallons (U.S. liquid)
bars	.9869	Atmospheres		.001	liters
	1020	.kg./sq. meter		.00211	pints (U.S. liquid)
btu	.778.2	foot-pounds		00106	quarts (U.S. liquid)
	252	.gram-calories	cubic feet	.28320	.cu. cms.
	.000393	.horsepower-hours		1728	.cu. inches
	1055	.joules		.028	.cu. meters
	.252	.kilogram-calories		.037	.cu. yards
	.000293	.kilowatt-hours		7.48	gallons (U.S. liquid)
btu/cu. ft.	.8.9	.kilogram-calories/		28.32	liters
cu. meter				59.84	pints (U.S. liquid)
btu/hr	.216	.ft.-pounds/sec.		29.92	quarts (U.S. liquid)
	.007	.gram-cal./sec.	cubic feet/min.	.472	.cu. cms./sec.
	.000393	.horsepower		.125	.gallons/sec.
	.293	.watts		.472	.liters/sec.
btu ft./hr. sq. ft. °F	.14.88	.Cal-cm/hr. sq. cm °C		62.43	pounds water/min.
	8890.0	.Cal. gm/cu. meter	cubic inches	.16.39	.cu. cms.
btu/lb	.0.556	.calories/gm.		.000579	.cu. ft.
btu/lb. °F	.1.0	.calories/gm °C		.0000164	.cu. meters
btu/sec.	.1.055	.kW		.0000214	.cu. yards
btu/sq. ft.-min	.122	.watts/sq. in.		.00433	.gallons
calories-gram	.00397	.Btu		.0164	liters
calorie-Kg	.3.97	.Btu		.0346	pints (U.S. liquid)
calorie-Kg/cu. meter	0.1124	.Btu/cu. ft. @		.0173	quarts (U.S. liquid)
		.32°F 30" Hg	cubic meters	.1,000,000	.cu. cms.
calorie/hr. sq. cm.	.3.687	.Btu/hr. sq. foot		35.31	.cu. ft.
centiliters	.001	.liters		6102	.cu. inches
centimeters	.0328	.feet		1.308	.cu. yards
	.0394	.inches		264.2	gallons (U.S. liquid)
	.00001	.kilometers		1000	.liters
	.01	.meters		2113	pints (U.S. liquid)
	.0000062	.miles		1057	quarts (U.S. liquid)
	10	.millimeters	cubic yards	.764,600	.cu. cms.
	393.7	.mils		27	.cu. ft.
	.0109	.yards		46656	.cu. inches
	1000	.microns		.765	.cu. meters
centimeters of mercury	.0132	.atmospheres	decigrams	.1	.grams
	.446	.ft. of water	deciliters	.1	.liters
	136	.kg./sq. meter	decimeters	.1	.meters
	27.85	.pounds/sq. ft.	degrees (angle)	.011	.quadrants
	.193	.pounds/sq. in.		.0175	.radians
centimeters/sec.	.1.969	.feet/min.		3600	.seconds
	.0328	.feet/sec.	degrees/sec.	.0175	.radians/sec.
	.036	.kilometers/hr.		.0167	.revolutions/min.
	6	.meters/min.		.00278	.revolutions/sec.
	.0224	.miles/hr.	dekagrams	.10	.grams
	.00373	.miles/min.	dekaliters	.10	.liters
centimeters/sec./sec.	.0328	.ft./sec./sec.	dekameters	.10	.meters
	.036	.kms./hr.sec.	dynes/sq. cm.	.000000987	.atmospheres
	.01	.meters/sec.sec.		.0000295	.in. of mercury (at 0°C.)
	.0224	.miles/hr.sec.		.000402	.in. of water (at 4°C)
centipoise	.01	.gr.cm.-sec.		.00001	.bars
	.00067	.pound/ft.-sec.	feet	.30.48	.centimeters
	2.4	.pound/ft.-hr.		.000305	.kilometers
				.305	.meters
				.000189	.miles (stat.)
				304.8	.millimeters

GENERAL CONVERSION FACTORS (Cont'd)

MULTIPLY	BY	TO OBTAIN	MULTIPLY	BY	TO OBTAIN
feet of water	.0295	atmospheres	grams/sq. cm.	2.048	pounds/sq. ft.
	.883	in. of mercury	gram-calories	.00397	btu
	.0305	kgs./sq. cm.		3.086	foot-pounds
	304.8	kgs./sq. meter		.00000156	horsepower-hrs.
	62.43	pounds/sq. ft.		.00000116	kilowatt-hrs.
	.434	pounds/sq. in.		.00116	watt-hrs.
feet/min.	.508	cms./sec.	gram-calories/sec.	14.29	btu/hr.
	.0167	feet/sec.	hectares	2.471	acres
	.0183	kms./hr.		10760	sq. feet
	.305	meters/min.	hectograms	100	grams
	.0114	miles/hr.	hectoliters	100	liters
	30.48	cms./sec.	hectometers	100	meters
feet/sec.	1.097	kms./hr.	hectowatts	100	watts
	18.29	meters/min.	horsepower	.4244	btu/min.
	.682	miles/hr.		33000	foot-lbs./min.
	.0114	miles/min.		550	foot-lbs./sec.
feet/sec./sec.	30.48	cms./sec./sec.	horsepower (metric)	.986	horsepower
	1.097	kms./hr./sec.	horsepower	1.014	horsepower (metric)
	.305	meters/sec./sec.		10.68	kg.-calories/min.
foot-pounds	.00129	btu		.746	kilowatts
	.324	gram-calories		745.7	watts
	.00000505	horsepower-hrs.	horsepower-hours	.2547	btu
	1.356	joules		1,980,000	foot-lbs.
	.000324	kg.-calories		641,190	gram-calories
	.138	kg.-meters		2,684,000	joules
	.00000377	kilowatt-hrs.		641.7	kg.-calories
foot-pounds/sec.	4.63	btu/hr.		273,700	kg.-meters
	.0772	btu/min.		.746	kilowatt-hrs.
	.00182	horsepower	hours	.0417	days
	.00195	kg.-calories/min.		.00595	weeks
	.00136	kilowatts		25.4	millimeters
	.00001	kilometers		1000	mils
gallons	.3785	cu. cms.		.0278	yards
	.134	cu. feet	in. of mercury	.0334	atmospheres
	.231	cu. inches		1.133	feet of water
	.00379	cu. meters		.0345	kgs./sq. cm.
	.00495	cu. yards		345.3	kgs./sq. meter
	3.785	liters		70.73	pounds/sq. ft.
gallons (liq. Br. imp.)	1.201	gallons (U.S. liquid)		.491	pounds/sq. in.
gallons (U.S.)	.833	gallons (imp.)	in. of water (at 4°C)	.00246	atmospheres
gallons of water	8.34	gallons (imp.)		.0736	inches of mercury
gallons/min.	.00223	cu. feet/sec.		.00254	kgs./sq. cm.
	.0631	liters/sec.		.578	ounces/sq. in.
	8.021	cu. feet/hr.		5.204	pounds/sq. ft.
grains (troy)	.1	grains (avdp.)		.0361	pounds/sq. in.
	.0648	grams	joules	.000949	btu
	.00208	ounces (avdp.)		.774	foot-pounds
grams	15.43	grains (troy)		.000239	kg.-calories
	.0000981	joules/cm.		.102	kg.-meters
	.00981	joules/meter (newtons)		.000278	watt-hrs.
	.001	kilograms	kilograms	1000	grams
	1000	milligrams		.0981	joules/cm.
	.0353	ounces (troy)		9.807	joules/meter (newtons)
	.00221	pounds		2.205	pounds
grams/cu. cm.	62.43	pounds/cu. ft.		.000984	tons (long)
	.0361	pounds/cu. in.		.00110	tons (short)
grams/liter	58.42	grains/gal.		35.27	ounces (avdp.)
	8.345	pounds/1,000 gal.			
	.0624	pounds/cu. ft.			

GENERAL CONVERSION FACTORS (Cont'd)

MULTIPLY	BY	TO OBTAIN	MULTIPLY	BY	TO OBTAIN
kilograms/cu. meter	.001	grams/cu. cm.	meters	.100	centimeters
	.0624	pounds/cu. ft		3.281	feet
	.0000361	pounds/cu. in.		39.37	inches
kilograms/sq. cm.	.980665	dynes/sq. cm.		.001	kilometers
	.968	atmospheres		.00054	miles (nautical)
	32.81	feet of water		.000621	miles (statute)
	28.96	inches of mercury		1000	millimeters
	2048	pounds/sq. ft.		1.094	yards
	14.22	pounds/sq. in.	meters/min.	1.667	cms./sec.
kilograms/sq. meter	.0000968	atmospheres		3.281	feet/min.
	.0000981	bars		.0547	feet/sec.
	.00328	feet of water		.06	kms./hr.
	.0029	inches of mercury		.0373	miles/hr.
	.205	pounds/sq. ft.	meters/sec.	196.8	feet/min.
	.00142	pounds/sq. in.		3.281	feet/sec.
	98.07	dynes/sq. cm.		3.6	kilometers/hr.
kilograms/sq. mm	1,000,000	kgs./sq. meter		.06	kilometers/min.
kilogram-calories	3.968	btu		2.237	miles/hr.
	3086	foot-pounds		.0373	miles/min.
	.00156	horsepower-hrs.	meters/sec./sec.	.100	cms./sec./sec.
	4183	joules		3.281	ft./sec./sec.
	1163	kilowatt-hrs.		3.6	kms./hr.sec.
kilogram-meters	7.233	foot-pounds		2.237	miles/hr./sec.
	9.807	joules	micrograms	.000001	grams
	.00234	kg.-calories	micrograms/cu. ft.	.000001	grams/cu. ft
	.0000272	kilowatt-hrs.		.0000353	grams/cu. meter
kiloliters	1.000	liters		.00000022	lbs./1000 cu. ft.
kilometers	100,000	centimeters		35.314	micrograms/cu. meter
	3281	feet	micrograms/cu. m.	0.001	milligrams/cu. m.
	39,370	inches		0.02832	micrograms/cu. ft
	1000	meters	microhms	.000001	ohms
	.621	miles (statute)	microliters	.000001	liters
	.54	miles (nautical)	micromicrons	.000000000001	meters
	1,000,000	millimeters	microns	.000001	meters
	1093.6	yards	miles (statute)	.160,900	centimeters
kilometers/hr.	27.78	cms./sec.		5280	feet
	54.68	feet/min.		63360	inches
	.911	feet/sec.		1.609	kilometers
kilowatts	.3413	btu/hr		1609	meters
	44,260	foot-lbs./min.		.868	miles (nautical)
	737.6	foot-lbs.sec.		1760	yards
	1.341	horsepower	miles/hr.	44.70	cms./sec.
	14.34	kg.-calories/min.		88	ft./min.
	1000	watts		1.467	ft./sec.
kilowatt-hrs.	.3413	btu		1.609	kms./hr.
	2,655,000	foot-lbs.		.0268	kms./min.
	859,850	gram calories		26.82	meters/min.
	1.341	horsepower-hours		.0167	miles/min.
	3,600,000	joules	milligrams	.001	grams
	860.5	kg.-calories	milligrams/liter	1.0	parts/million
	367,100	kg.-meters	milliliters	.001	liters
	3.53	pounds of water evaporated from and at 212°F	millimeters	.1	centimeters
	22.75	pounds of water raised from 62° to 212°F.		.00328	feet
liters	1000	cu. cm.		.0394	inches
	.0353	cu. ft.		.000001	kilometers
	61.02	cu. inches		.001	meters
	.001	cu. meters		.000000621	miles
	.00131	cu. yards		39.37	mils
	.264	gallons (U.S. liquid)		.00109	yards
	2.113	pints (U.S. liquid)	mils	.00254	centimeters
	1.057	quarts (U.S. liquid)		.0000833	feet
liters/min.	.00589	cu. ft./sec.		.001	inches
	.0044	gals./sec.			

GENERAL CONVERSION FACTORS (Cont'd)

MULTIPLY	BY	TO OBTAIN	MULTIPLY	BY	TO OBTAIN
minutes (angles)	.0167	degrees	pounds/sq. ft.	.000473	atmospheres
	.000185	quadrants		.016	feet of water
	.000291	radians		.0141	inches of mercury
	60	seconds		.192	inches of water
minutes (time)	.0000992	weeks		4.882	kgs./sq. meter
	.000694	days		.111	ounces/sq. inch
	.0167	hours		.00694	pounds/sq. inch
	60	seconds	pounds/sq. inc.	.068	atmospheres
ounces	.4375	grains		2.307	feet of water
	28.35	grains		2.036	inches of mercury
	.0625	pounds		27.71	inches of water
	.912	ounces (troy)		703.1	kgs./sq. meter
ounces (fluid)	1.805	cu. inches		16	ounces/sq. inch
	.0296	liters		144	pounds/sq. foot
ounces (troy)	.480	grains	quadrants (angle)	.90	degrees
	31.1	grams		5400	minutes
	1.097	ounces (avdp.)		1.571	radians
ounce/sq. in.	.4309	dynes/sq. cm.		324,000	seconds
	.0625	pounds/sq. in.	quarts (liquid)	.946.4	cu. cms.
	1.732	inches w.c.		.0334	cu. ft.
parts/million	.0584	grains/U.S. gal.		57.75	cu. inches
	.0702	grains/imp. gal.		.000946	cu. meters
	8.345	pounds/million gal.		.00124	cu. yards
ppm (volume)	.385,100,000	lb/ft ³		.25	gallons
	0.02404	micrograms/cu. m.		.946	liters
ppm (weight)	.0012	micrograms/cu. m.	radians	.57.3	degrees
pints (liquid)	.473.2	cubic cms.		3438	minutes
	.0167	cubic ft.		.637	quadrants
	28.87	cubic inches		206,300	seconds
	.000473	cubic meters	radian/sec.	.9.55	rpm
	.000619	cubic yards	rpm	.0.1047	rad./sec.
	.125	gallons	seconds (angle)	.000278	degrees
	.473	liters		.0167	minutes
	.5	quarts (liquid)	square centimeters	.197,300	circular mils
poise	1.0	gram/cm.-sec.		.00108	sq. feet
pounds	7000	grains		.155	sq. inches
	453.6	grams		.0001	sq. meters
	4.448	joules/meter (newtons)		100	sq. millimeters
	.454	kilograms		.00012	sq. yards
	16	ounces	square feet	.929	sq. cms.
	14.58	ounces (troy)		144	sq. inches
	.0005	tons (short)		.093	sq. meters
pounds of water	.016	cu. ft.		.000000359	sq. miles
	27.68	cu. inches		92900	sq. millimeters
	.12	gallons		.111	sq. yards
pounds of water/min.	.000267	cu. ft/sec.	square inches	.6.452	sq. cms.
pounds/cu. ft.	.016	grams/cu. cm.		.00694	sq. ft.
	16.02	kgs./cu. meter		645.2	sq. millimeters
	133,700	ppm (weight)		1,000,000	sq. mils
	.000579	pounds/cu. in.		.000772	sq. yards
pounds/cu. in.	.27.68	grams/cu. cm.	square kilometers	.10,760,000	sq. ft.
	27680	kgs./cu. meter		1,000,000	sq. meters
	1728	pounds/cu. ft.		.386	sq. miles
pounds/ft.	1.488	kgs./meter			
pounds/in.	.178.6	grams/cm.			

GENERAL CONVERSION FACTORS (Cont'd)

MULTIPLY	BY	TO OBTAIN	MULTIPLY	BY	TO OBTAIN
square meters	10000	.sq. cms.	ton refrigeration (U.S.)	.12,000	.btu/hr
	10.76	.sq. ft.		83.33	.lb. ice melted per hr. from and at 32°F
	1550	.sq. inches	watts	.3.413	.btu/hr.
	1,000,000	.sq. millimeters		.0569	.btu/min.
	1,196	.sq. yards		44.27	.ft.-lbs./min.
square miles	.27,880,000	.sq. ft.		.738	.ft.-lbs./sec.
	2.590	.sq. kms.		.00134	.horsepower
	2,590,000	.sq. meters		.00136	.horsepower (metric)
	3,098,000	.sq. yards		.0143	.kg.-calories/min.
square millimeters	.1973	.circular mils		.001	.kilowatts
	.01	.sq. cms.	watt-hours	.3.413	.btu
	.0000108	.sq. ft.		2656	.foot-lbs.
	.00155	.sq. inches		860.5	.gram-calories
therms	100,000	.btu		.00134	.horsepower-hours
tons (long)	.1016	.kilograms		.861	.kilogram-calories
	2240	.pounds		367.2	.kologram-meters
	1.12	.tons (short)		.001	.kilowatt-hours
tons (metric)	1000	.kilograms	watt/sq.cm.	.3170.0	.btu/hr./sq. foot
	2205	.pounds	$\frac{\text{watt cm}}{\text{sq. cm. } ^\circ\text{F}}$.57.79	$\frac{\text{btu-ft}}{\text{hr. sq. ft. } ^\circ\text{F}}$
tons (short)	.907.2	.kilograms			
	32000	.ounces			
	2917	.ounces (troy)			
	2000	.pounds			
	2430	.pounds (troy)			
	.893	.tons (long)			
	.908	.tons (metric)			

TEMPERATURE CONVERSIONS

$$^\circ\text{Fahrenheit} = 9/5^\circ\text{C} + 32$$

$$^\circ\text{Celsius} = 5/9 (^\circ\text{F} - 32)$$

$$^\circ\text{Rankine} = ^\circ\text{F absolute} = ^\circ\text{F} + 459.69$$

$$^\circ\text{Kelvin} = ^\circ\text{C absolute} = ^\circ\text{C} + 273.16$$

Fahrenheit to Celsius				Celsius to Fahrenheit			
°F	°C	°F	°C	°C	°F	°C	°F
0	-17.78	950	510.0	0	32	850	1562
20	-6.67	1000	537.8	10	50	900	1652
40	4.44	1100	593.3	20	68	950	1742
60	15.56	1200	648.9	30	86	1000	1832
80	26.67	1300	704.4	40	104	1050	1922
100	37.78	1400	760.0	50	122	1100	2012
120	48.89	1500	815.6	60	140	1150	2102
140	60.00	1600	871.1	70	158	1200	2192
160	71.11	1700	926.7	80	176	1250	2282
180	82.22	1800	982.2	90	194	1300	2372
200	93.33	1900	1038	100	212	1350	2462
250	121.1	2000	1093	150	302	1400	2552
300	148.9	2100	1149	200	392	1450	2642
350	176.7	2200	1204	250	482	1500	2732
400	204.4	2300	1260	300	572	1550	2822
450	232.2	2400	1316	350	662	1600	2912
500	260.0	2500	1371	400	752	1650	3002
550	287.8	2600	1427	450	842	1700	3092
600	315.6	2700	1482	500	932	1750	3182
650	343.3	2800	1538	550	1022	1800	3272
700	371.1	2900	1593	600	1112	1850	3362
750	398.9	3000	1649	650	1202	1900	3452
800	426.7	3200	1760	700	1292	1950	3542
850	454.4	3400	1871	750	1382	2000	3632
900	482.2	3600	1982	800	1472	2050	3722

PRESSURE CONVERSIONS

inches water ("w.c.)	ounces/ sq in (osi)	lb/sq in (psi)	inches mercury ("Hg)	millibars (mbar)	kilograms/ sq cm (kg/cm ²)	millimeters water (mm H ₂ O)	kilo- pascals (kPa)
.04	.023	.001	.003	.1	.0001	1	.01
.1	.058	.004	.007	.25	.0003	2.54	.02
.17	.1	.006	.013	.42	.0004	4.4	.04
.2	.115	.007	.015	.5	.0005	5.08	.05
.35	.2	.013	.026	.87	.0009	8.8	.09
.39	.227	.014	.029	.97	.001	10	.1
.40	.23	.015	.029	1	.0010	10.2	.1
.5	.29	.018	.037	1.24	.0013	12.7	.12
.787	.45	.028	.058	1.96	.002	20	.2
.80	.46	.029	.059	2	.0020	20.4	.2
.87	.5	.031	.064	2.16	.0022	22	.22
1	.58	.036	.074	2.49	.0025	25.4	.25
1.73	1	.063	.127	4.30	.0044	44	.43
2	1.15	.072	.147	4.98	.0051	50.8	.5
2.01	1.16	.073	.148	5	.0051	51	.5
2.77	1.6	.1	.204	6.89	.0070	70.3	.69
3	1.73	.108	.221	7.46	.0076	76.2	.75
3.46	2	.125	.254	8.61	.0088	87.9	.86
4	2.31	.144	.294	9.95	.010	101.6	1
4.02	2.32	.145	.296	10	.010	102	1
5	2.89	.181	.368	12.5	.013	127	1.25
5.2	3	.188	.382	12.9	.013	131.9	1.29
5.54	3.2	.2	.407	13.8	.014	140.7	1.38
6	3.46	.216	.441	14.9	.015	152.4	1.49
6.93	4	.25	.51	17.2	.018	175.8	1.72
7	4.04	.253	.515	17.4	.018	177.8	1.74
8	4.62	.289	.588	19.9	.020	203.2	1.99
8.03	4.64	.29	.591	20	.020	204	2
8.66	5	.313	.637	21.5	.022	219.8	2.15
9	5.2	.325	.662	22.4	.023	228.6	2.24
10	5.77	.361	.735	24.9	.025	254	2.49
10.39	6	.375	.764	25.9	.026	263.8	2.59
11	6.35	.397	.809	27.4	.028	279.4	2.74
12	6.93	.433	.882	29.9	.030	304.8	2.99
12.05	6.96	.435	.887	30	.031	306	3
12.12	7	.438	.891	30.2	.031	307.7	3.02
13	7.51	.469	.956	32.4	.033	330.2	3.24
13.6	7.85	.491	1	33.8	.035	345.4	3.38
13.86	8	.5	1.02	34.5	.035	351.6	3.45
14	8.08	.505	1.03	34.9	.036	355.5	3.49
15	8.66	.541	1.10	37.4	.038	381	3.74
15.59	9	.563	1.15	38.8	.04	395.6	3.88
16	9.24	.578	1.18	39.8	.041	406.4	3.98
16.06	9.28	.58	1.18	40	.041	408	4
17	9.82	.614	1.25	42.3	.043	431.8	4.23
17.32	10	.625	1.27	43.1	.044	439.6	4.31
18	10.39	.649	1.32	44.8	.046	457.2	4.48
19	10.97	.686	1.4	47.3	.048	482.6	4.73
19.05	11	.688	1.40	47.4	.048	483.6	4.74
20	11.55	.722	1.47	49.8	.051	508	4.98

PRESSURE CONVERSIONS (Cont'd)

inches water ("w.c.)	ounces/ sq in (osi)	lb/sq in (psi)	inches mercury ("Hg)	millibars (mbar)	kilograms/ sq cm (kg/cm ²)	millimeters water (mm H ₂ O)	kilo- pascals (kPa)
20.1	11.6	.725	1.48	50	.051	510	5
20.78	12	.75	1.53	51.7	.053	528	5.17
21	12.12	.758	1.54	52.3	.053	533	5.23
22	12.7	.794	1.62	54.8	.056	559	5.48
22.52	13	.813	1.66	56.0	.057	572	5.60
23	13.28	.83	1.69	57.3	.058	584	5.73
24	13.86	.866	1.76	59.7	.061	610	5.98
24.1	13.92	.87	1.77	60	.061	612	6
24.25	14	.875	1.78	60.3	.062	615	6.03
25	14.43	.902	1.84	62.3	.064	635	6.23
25.98	15	.938	1.91	64.6	.066	659	6.46
26	15.01	.938	1.91	64.7	.066	660	6.47
27	15.59	.974	1.99	67.2	.069	686	6.72
27.2	15.7	.982	2	67.7	.069	711	6.77
27.71	16	1	2.04	68.9	.070	703	6.89
28	16.17	1.01	2.06	69.7	.071	711	6.97
28.11	16.24	1.02	2.07	70	.071	714	7
29	16.74	1.05	2.13	72.2	.074	737	7.22
29.44	17	1.06	2.16	73.3	.075	747	7.33
30	17.32	1.08	2.21	74.7	.076	762	7.47
31	17.9	1.12	2.28	77.2	.079	787	7.72
31.18	18	1.13	2.29	77.6	.079	791	7.76
32	18.48	1.16	2.35	79.7	.081	813	7.97
32.13	18.56	1.16	2.36	80	.082	816	8
32.91	19	1.19	2.42	81.9	.084	835	8.19
33	19.05	1.19	2.43	82.2	.084	838	8.22
34	19.63	1.23	2.5	84.7	.086	864	8.47
34-64	20	1.25	2.55	86.2	.088	879	8.62
35	20.21	1.26	2.57	87.2	.089	889	8.72
36	20.79	1.3	2.65	89.6	.091	914	8.96
36.14	20.88	1.31	2.66	90	.092	918	9
36.37	21	1.31	2.67	90.5	.092	923	9.05
37	21.36	1.34	2.72	92.1	.094	940	9.21
38	21.94	1.37	2.79	94.6	.097	965	9.46
38.1	22	1.38	2.80	94.8	.097	967	9.48
39	22.52	1.41	2.87	97.1	.099	991	9.71
39.37	22.73	1.42	2.89	98.0	.1	1000	9.80
39.84	23	1.44	2.93	99.1	.101	1011	9.91
40	23.09	1.44	2.94	99.6	.102	1016	9.96
40.16	23.20	1.45	2.96	100	.102	1020	10
40.8	23.56	1.47	3	101.5	.104	1036	10.2
41	23.67	1.48	3.01	102.0	.104	1041	10.2
41.57	24	1.5	3.06	103.4	.106	1055	10.3
42	24.25	1.52	3.09	104.5	.107	1067	10.5
43	24.83	1.55	3.16	107	.109	1092	10.7
43.3	25	1.56	3.18	107.7	.11	1099	10.8
44	25.4	1.59	3.24	109.5	.112	1118	11
45	26	1.63	3.31	112	.114	1144	11.2
46	26.56	1.66	3.38	114.5	.117	1168	11.5
46.76	27	1.69	3.44	116.3	.118	1184	11.6

PRESSURE CONVERSIONS

inches water ("w.c.)	ounces/ sq in (osi)	lb/sq in (psi)	inches mercury ("Hg)	millibars (mbar)	kilograms/ sq cm (kg/cm ²)	millimeters water (mm H ₂ O)	kilo- pascals (kPa)
47	27.14	1.7	3.46	116.9	.119	1194	11.7
48	27.71	1.73	3.53	119.4	.122	1219	12
48.5	28	1.75	3.57	120.7	.123	1232	12.1
49	28.29	1.77	3.60	121.9	.124	1245	12.2
50	28.87	1.80	3.68	124.4	.127	1270	12.5
50.23	29	1.81	3.69	125	.128	1276	12.5
51	29.45	1.84	3.75	126.9	.13	1295	12.7
51.96	30	1.88	3.82	129.3	.132	1320	12.9
52	30.02	1.88	3.82	129.4	.132	1321	12.9
53	30.6	1.91	3.9	131.9	.135	1346	13.2
53.69	31	1.94	3.95	133.6	.136	1364	13.4
54	31.18	1.95	3.97	134.4	.137	1372	13.4
54.4	31.41	1.96	4	135.4	.138	1382	13.5
55.4	32	2	4.07	137.8	.141	1408	13.8
68	39.26	2.45	5	169.2	.173	1727	16.9
78.7	45.46	2.84	5.79	195.8	.2	2000	19.6
80.32	46.4	2.9	5.91	200	.204	2040	20
81.6	47.11	2.94	6	203	.207	2072	20.3
83.14	48	3	6.11	207	.211	2112	20.7
95.2	55	3.44	7	237	.242	2418	23.7
108.8	62.8	3.93	8	271	.276	2763	27.1
110.8	64	4	8.15	276	.282	2816	27.6
120.5	69.6	4.35	8.87	300	.306	3060	30
138.6	80	5	10.2	345	.352	3517	34.5
160.6	92.8	5.8	11.8	400	.408	4080	40
166.3	96	6	12.2	414	.422	4223	41.4
194	112	7	14.3	483	.493	4927	48.3
196.9	113.7	7.1	14.5	490	.5	5000	49.0
200.8	116	7.25	14.8	500	.510	5100	50
221.7	128	8	16.3	552	.563	5631	55.2
241	139	8.7	17.7	600	.612	6120	60
249.4	144	9	18.3	621	.634	6335	62.1
277.1	160	10	20.4	689	.703	7033	68.9
281.1	162	10.15	20.7	700	.714	7140	70
321.3	186	11.6	23.6	800	.816	8160	80
361.4	209	13.05	26.6	900	.918	9180	90
393.7	227	14.21	28.9	980	1	10,000	98.0
401.6	232	14.5	29.6	1000	1.02	10,200	100
415.7	240	15	30.6	1034	1.06	10,559	103.4
554	320	20	40.7	1378	1.41	14,072	137.8
693	400	25	51	1724	1.76	17,602	172.4
831	480	30	61.1	2068	2.11	21,107	206.8
970	560	35	71.3	2414	2.46	24,638	241.3
1108	640	40	81.5	2757	2.81	28,143	275.8
1386	800	50	101.9	3449	3.52	35,204	344.7
1663	960	60	122.3	4138	4.22	42,240	413.7
1940	1120	70	142.6	4827	4.93	49,276	482.6
2217	1280	80	163.0	5516	5.63	56,312	551.6
2494	1440	90	183.4	6206	6.33	63,348	620.5
2771	1600	100	203.8	6895	7.04	70,383	689.5

INDEX

Abbreviations	61	Flame Tip Temp.	52	Orifices	
Air		Flow		capacities	
effect of altitude	20	and C_v	16	high pressure	9-11
effect of pressure	20	and duct velocity	17	low pressure	5-8
effect of temp.	21	orifices	4	coefficients of discharge	4
infiltration	53	Flue Gas Analysis	52	flow formulas	4
pipe		Flue Sizing	53	Pipe	
sizing	16	Fume Incineration		capacities	54
pressure losses	12	heat requirements	45	dimensions	54
Air Heating		sizing	46	fittings	
heat requirements	45	Furnaces		dimensions	55
Alloys		cold air infiltration	53	equivalent length	14
thermal capacities	40	flue sizing	53	flange templates	60
Area		thermal head	53	pressure losses	
of circles	57, 58	turndown	36	air	12
Available Heat		Gas/Air Mixtures	24	natural gas	13, 14
definition	35-36	Gases		oil	27, 28
charts	51	available heat	51	sizing	
Black Body Radiation	49	combustion products	23	air, gas & mixture	15
Blowers		constituents	22	air, quick method	15
as suction device	20	density	22	branch	16
fan laws	19	flame temp.	23	steam	32
horsepower	20	flame velocity	22	water	31
ratings	18, 19	flammability limits	22	Pressure, Conversions	69-71
Boilers		heat release	23	Propane	
Btu/hr. & H.P.	31	heating value	23	propane/air mixtures	24
conversion factors	30	ignition temp.	22	properties	22, 23
sizing steam pipe	32	mixtures	24	see also Gases	
Butane		pipe, sizing	16	Pyrometric Cones	50
butane/air mixtures	24	properties	22-24, 37	Radiant Tubes	43
properties	22, 23	specific gravity	22	Radiation, Black Body	49
C_v	16	specific volume	22	Refractory	44
Circles		stoichiometric ratio	22	Sheet Metal	
areas	57, 58	Heat		gauges	56
circumferences	57, 58	available	35-36	weights	56
Circumference		balance	35-36	Spray Washers	
of circles	57, 58	losses		heat loss factors	48
Coefficients of Discharge	4	general	35-36	heat requirements	48
Cones, Pyrometric	50	refractory	44	nozzle capacities	48
Conversions		spray washers	48	Steam	
boilers	30	tank	47	pipe sizing	32
h.p. & Btu/hr.	31	net output	35-36	properties	30
general	64 thru 68	required for processes	41	terminology	30
oil viscosity	26	storage, refractory	44	Symbols	
pressure	69	storage, tank	47	electrical	62, 63
temperature, °F & °C	69	transfer, equations	52	Temperature	
Crucibles		Heating Operations		°F & °C	68
capacities & dimensions	43	temp. & heat req'd.	41-42	flame tip	52
Drills		Liquid Heating		refractory face	44
sizes	59	sizing, burner	47	required, various processes	41
tap drill sizes	60	Metals		Thermal	
Duct Velocity	17	thermal capacities	40	capacities, metals & alloys	40
Efficiency, Thermal	36	Motors		efficiency	36
Electrical		current	34	head, furnaces	53
formulas	33	formulas	33	properties, materials	37
motor current	34	NEMA size starters	33	Turndown	
motor starters	33	Natural Gas, Properties	22-23	furnace	36
NEMA enclosures	34	Net Heat Output	35-36	Valves	
ohm's law	33	Nozzles		C_v and flow	16
symbols	62, 63	spray capacities	48	equivalent pipe length	14
wire specs	33	Ohm's Law	33	Velocity, Duct	17
Equivalent Length		Oil		Washers, spray	
pipe	14	ANSI specs	25	heat requirements	48
valves	14	heating value & °API	27	Wire	
Fan Laws	19	piping pressure losses	27, 28	gauges	56
Fans		piping temp. losses	29	specifications	33
see blowers		s.g. & °API	27	weights	56
		typical properties	26		
		viscosity conversions	26		

Section 1-Eclipse Equipment (numbers correspond to Bulletin numbers)

- 656 Selecting TVT Mixing Tees (Page 74)
- 810/812 Sizing Pilots, Blasts Tips & Pilot Mixers with Flow Charts (Page 76)

Section 2-Engineering Data

Part A- Combustion Data

- A-1 Flue Gas Analysis vs. Excess Air (Page 80)
- A-2 Flame Temperatures vs. Air Preheat & % Oxygen (Page 81)
- A-3 Available Heat vs. Oxygen Enrichment (Page 82)
- A-4 Available Heat-Extended Chart (Page 83)

Part C- Control systems

- C-1 Summary of Fuel-Air Ratio Control Systems for Nozzle Mixing Burners (Page 84)
- C-2 Ratio Control Using Proportioning Fixed Port Valves for Nozzle Mixing Burners (Page 85)
- C-3 Ratio Control Using Proportioning (Adjustable Characteristic) Valves for Nozzle Mixing Burners (Page 87)
- C-4 Ratio Control Using Cross-Connected Proportionators for Nozzle Mixing Burners (Page 89)
- C-5 Ratio Control Using Cross-Connected Proportionator with Bleed Fitting for Nozzle Mixing Burners (Page 91)
- C-6 Ratio Control Using Electronic Controllers for Nozzle Mixing Burners (Page 92)
- C-7 Excess Air Operation by Controlling Fuel Only for Nozzle Mixing Burners (Page 94)
- C-8 Excess Air Operation with Biased Proportionator for Nozzle Mixing Burners (Page 95)
- C-9 Excess Air Operation with Throttled Impulse (Adjustable Bleed) to Proportionator for Nozzle Mixing Burners (Page 96)
- C-10 Backpressure Compensation System for Cross-Connected Nozzle Mix Burner Systems (Page 97)

Part E- Emissions

- E-2 Conversion Factors for Emissions Calculations (Page 98)
- E-3 Correcting Emissions Readings to 3% O₂ or 11% O₂ Basis (Page 100)

Part H- Heat Recovery

- H-1 Recuperator Efficiency: Fuel Savings & Effectiveness (Page 101)

Part R- Regulations & Codes

- R-1 NFPA Requirements for Gas Burner Systems (Page 103)
- R-2 IRI Requirements for Gas Burner Systems (Page 105)

Section 3-Application Data

Part I- Incineration

- I-1 Heating Values of Flammable Liquids (Page 108)

Part L- Liquid Heating

- L-1 Immersion Tube Sizing (Page 110)
- L-2 Submerged Combustion (Page 112)
- L-3 Immersion Tubes-What Will The Stack Temperature Be? (Page 116)

Part O- Ovens

- O-1 Determining % O₂ in a Recirculating System (Page 117)

Tech Notes

Selecting TVT Mixing Tees—Bulletin 656

Series TVT two-valve mixing tees lack a tapered discharge sleeve, so they are not as efficient as LP Proportional Mixers. Their performance will also be strongly affected by downstream piping, so use them only where gas pressure available at the mixer connection exceeds mixture pressure by:

3" w.c. for natural or LP gas (except 166-24-TVT, which requires 7" w.c.)

6" w.c. for coke oven gas

8" w.c. for digester gas

For coke oven or digester gas, do not use the 84-16, 124-24 or 166-24; their gas inlets are too small. Also, do not use any of these mixers with producer gas. Producer gas flows far exceed the capacity of the gas orifices and inlet connections.

1. CFH air flow through the mixer (if customer specifies Btu/hr, divide by 100 to get cfh air).
 2. Air pressure available at mixer inlet, "w.c.
 3. Mixture pressure desired, "w.c.
-
1. Refer to Table I, page 75. Select a mixer whose maximum air capacity is higher than the required air flow.
 2. To size the air jet, subtract the mixture pressure from the air pressure. This gives you the air pressure drop available across the mixer. Then refer to the graph. Locate the desired air flow on the horizontal axis and the air pressure drop on the vertical axis. Locate the point where they intersect and then move right to the next diagonal line. That line represents the optimum jet size.
 3. Cross-check the air jet size against Table I to be sure it is within the range of sizes available for the mixer. If it isn't, select the next larger size of mixer to avoid taking a higher pressure drop.

Table I - TVT Mixer Data

Mixer Catalog No.	Maximum Air Flow, scfh	Air Jet Part No.	Range of Jet Sizes 1/32nds of an inch	Use Mixer With These Gases
44-17-TVT 64-16-TVT 66-24-TVT	900 2000 2000	0217- 0255- 0255-	10 - 16 12 - 25 12 - 25	Natural, LP, Coke Oven, Digester Natural, LP, Coke Oven, Digester Natural, LP, Coke Oven, Digester
84-16-TVT 86-24-TVT 124-24-TVT	3500 3500 8000	0225- 0225- 0695-	18 - 36 18 - 36 32 - 56	Natural, LP Natural, LP, Coke Oven, Digester Natural, LP
126-24-TVT 166-24-TVT 168-30-TVT	8000 15,000 15,000	0695- 0994- 0994-	32 - 56 36 - 80 36 - 80	Natural, LP, Coke Oven, Digester Natural, LP Natural, LP, Coke Oven, Digester

Figure I - Air Jet Sizing Chart

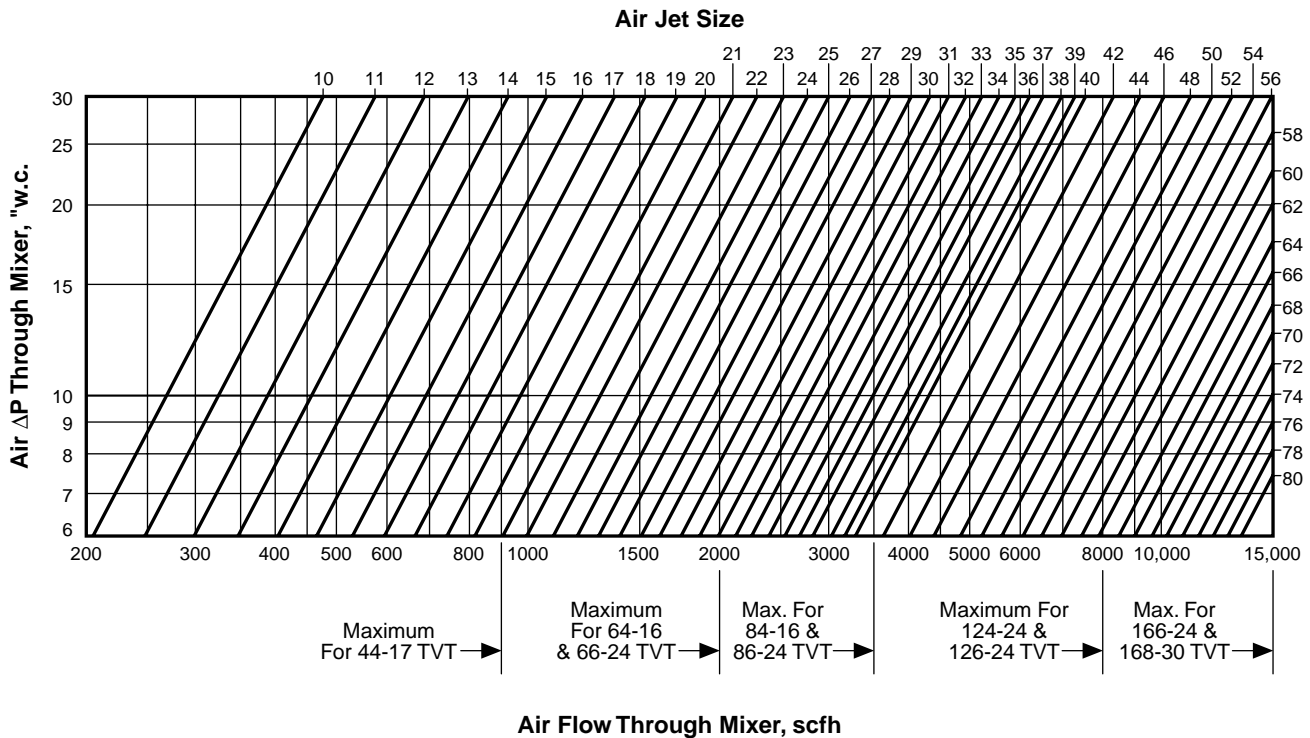

Tech Notes

Sizing Pilots, Blast Tips & Pilot Mixers With Flow Charts

To select the right equipment, you need to know:

1. Type and number of pilot or blast tips;
2. Btu/hr. at which each tip will fire;
3. Air pressure (P_A) available at the mixer inlet.

1. From the tip capacity chart on page 77, find the required mixture pressure. Do not exceed 8" w.c. mixture pressure, unless you've chosen a Cumapart (CP) tip or blast tip.

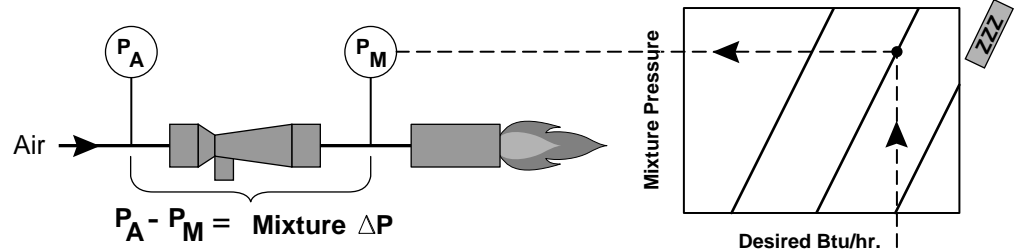

2. Subtract the mixture pressure (P_M) found in Step 1 from the air pressure (P_A) which is available at the mixer. The difference is the mixer pressure drop.

3. Figure the total air flow through the mixer by the following equation:

$$\text{cfh air} = \frac{\text{Btu/hr. per tip} \times \text{number of tips}}{100}$$

4. Next, refer to the mixer air capacity charts (page 78 for Series 121 mixers and page 79 for Series 131). To use the charts properly, follow the directions below:

1. Locate the mixer pressure drop figure in Step 2, and read to the right.

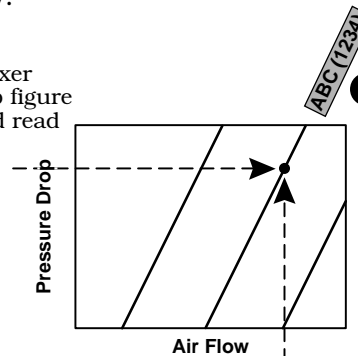

2. Locate the air flow figured in Step 3 and read up.

3. From the point where these lines cross, move right to the nearest mixer flow curve. This curve is the proper size mixer to use. The air jet part number is in parentheses.

5. Do not use the Series 121 mixers above 300 scfh air or the Series 131 mixers above 600 scfh air—otherwise pipe velocities are too high.

Capacities Of Eclipse Pilot & Blast Tips

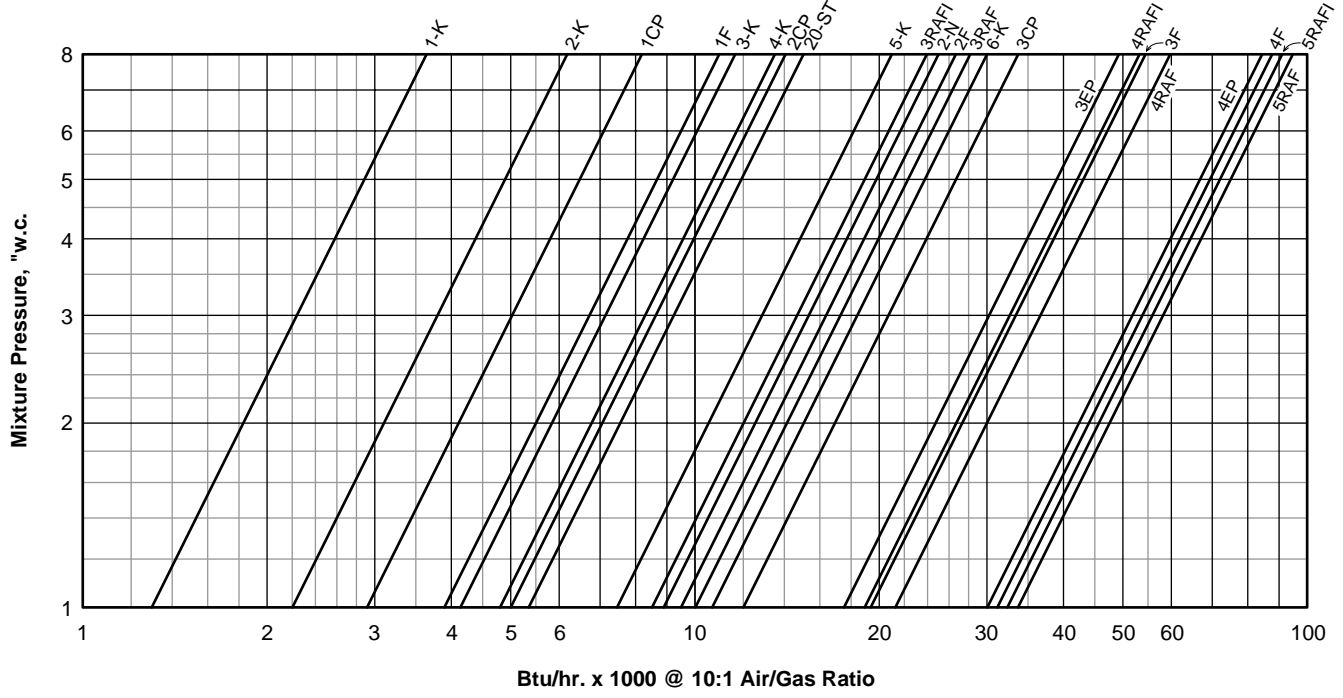

Series 121 Pilot Mixers Air Flow Capacity

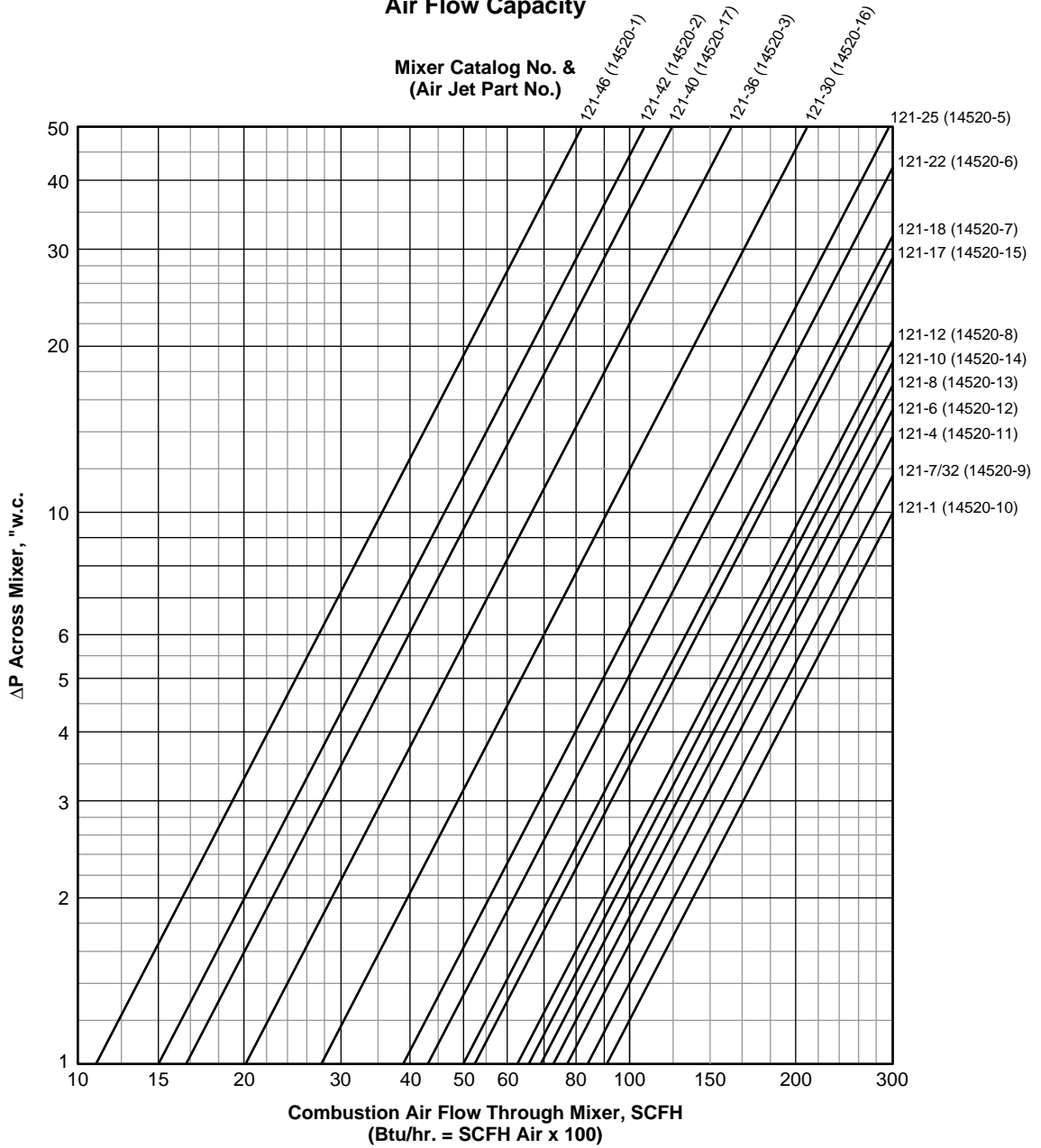

Series 131 Pilot Mixers Air Flow Capacity

Mixer Catalog No. &
(Air Jet Part No.)

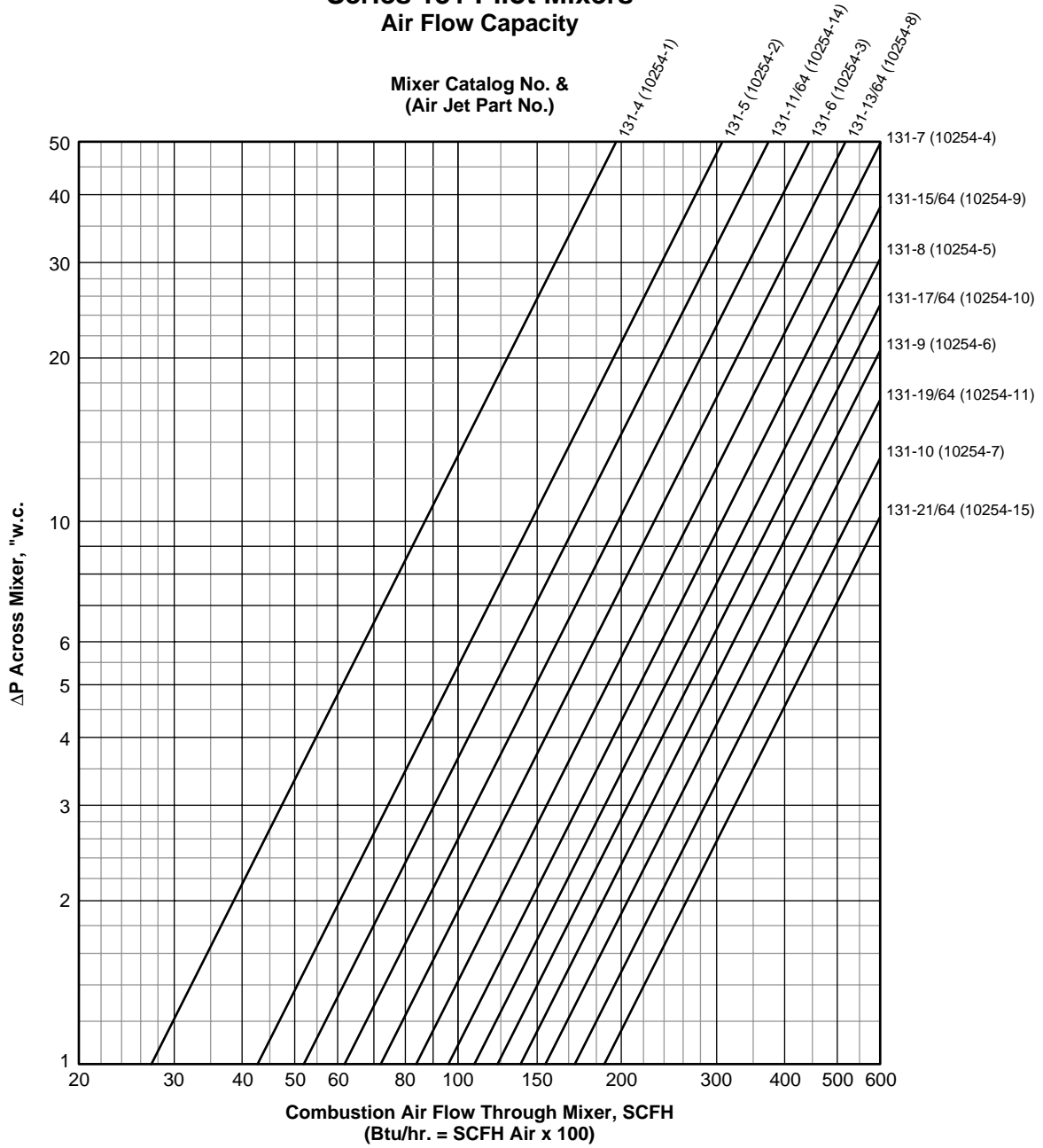

Tech Notes

Flue Gas Analysis vs. Excess Air

Eclipse Combustion Engineering Guide, p. 52

The graph below supplements the flue gas analysis chart on page 52 of the Combustion Engineering Guide, which extends to only 200% excess air. These curves are calculated for Birmingham Natural Gas, same as the Engineering Guide.

Figure 1:

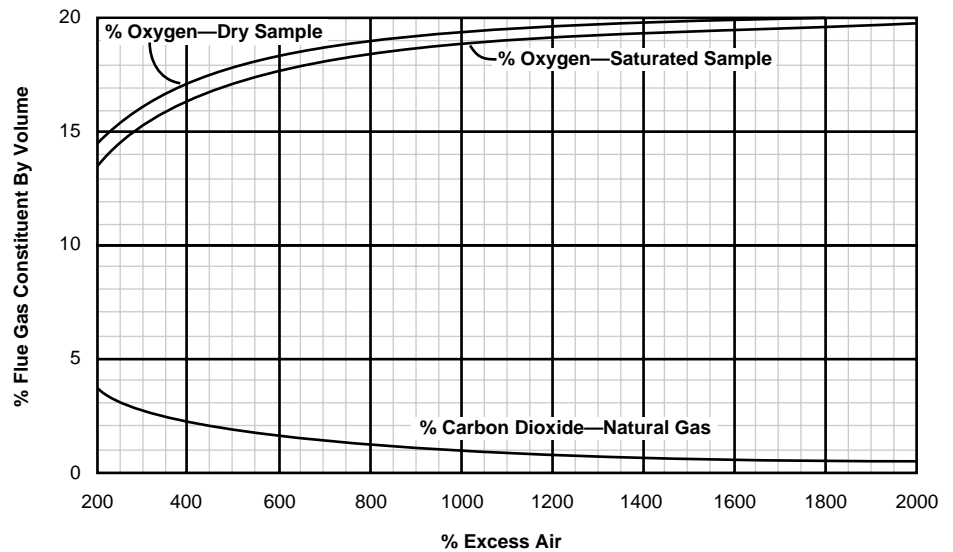

Tech Notes

Flame Temperatures vs. Air Preheat & % Oxygen

Both preheated air and oxygen enrichment increase the theoretical temperature of burner flames. The following graphs show their effect on the theoretical flame temperature of natural gas, which, with 60°F combustion air and 21% oxygen, would be about 3500 - 3550° F.

Figure 1:

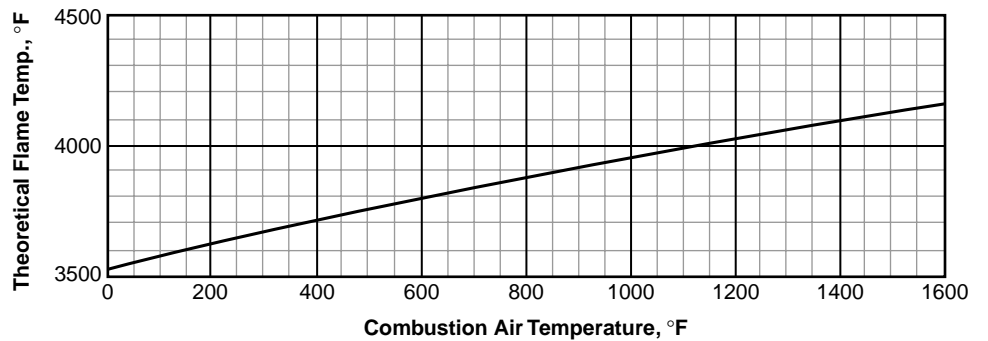
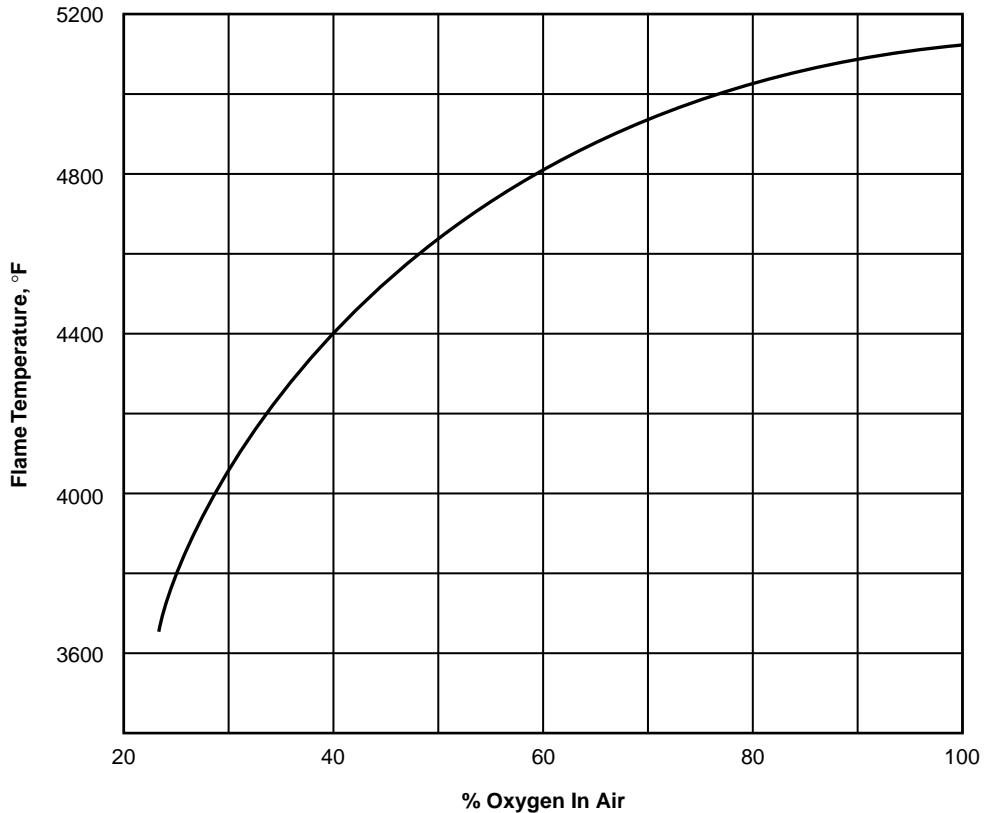

Figure 2:



Tech Notes

Available Heat vs. Oxygen Enrichment

The graph below shows available heat as a function of flue gas temperature and percent oxygen in the combustion air stream. These curves were calculated for natural gas with combustion air at 60°F.

Figure 1:

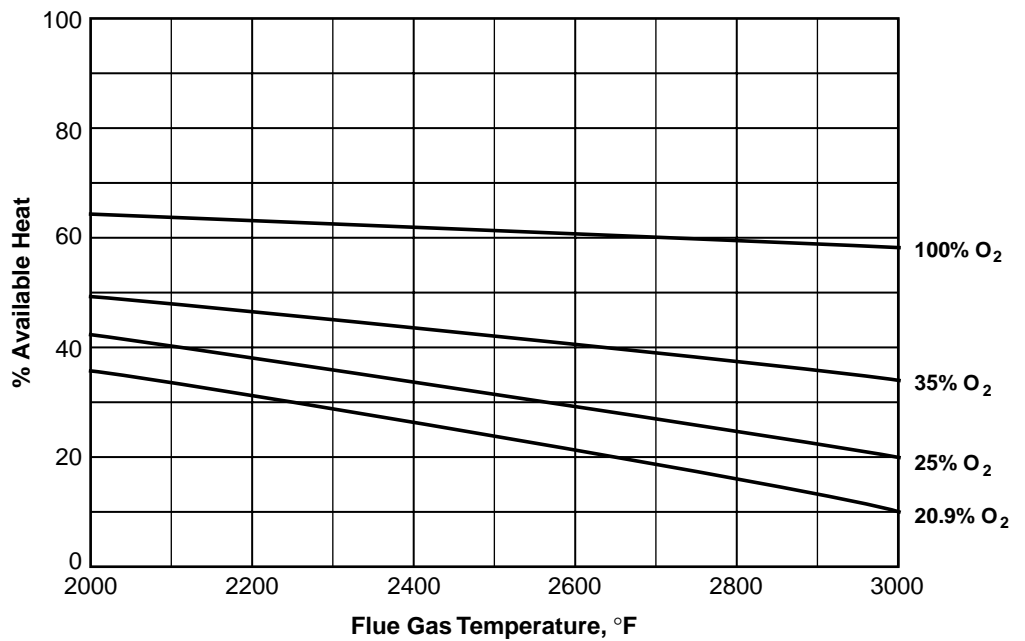

Tech Notes

Available Heat—Extended Chart

Eclipse Combustion Engineering Guide, p. 51

Page 51 of the Eclipse Combustion Engineering Guide carries two available heat charts, but unfortunately, the more useful one of the two doesn't cover flue gas temperatures below 1000°F. The chart below, calculated from the same conditions as the Engineering guide chart, extends these curves down to 300°F flue gas temperature.

Figure 1:

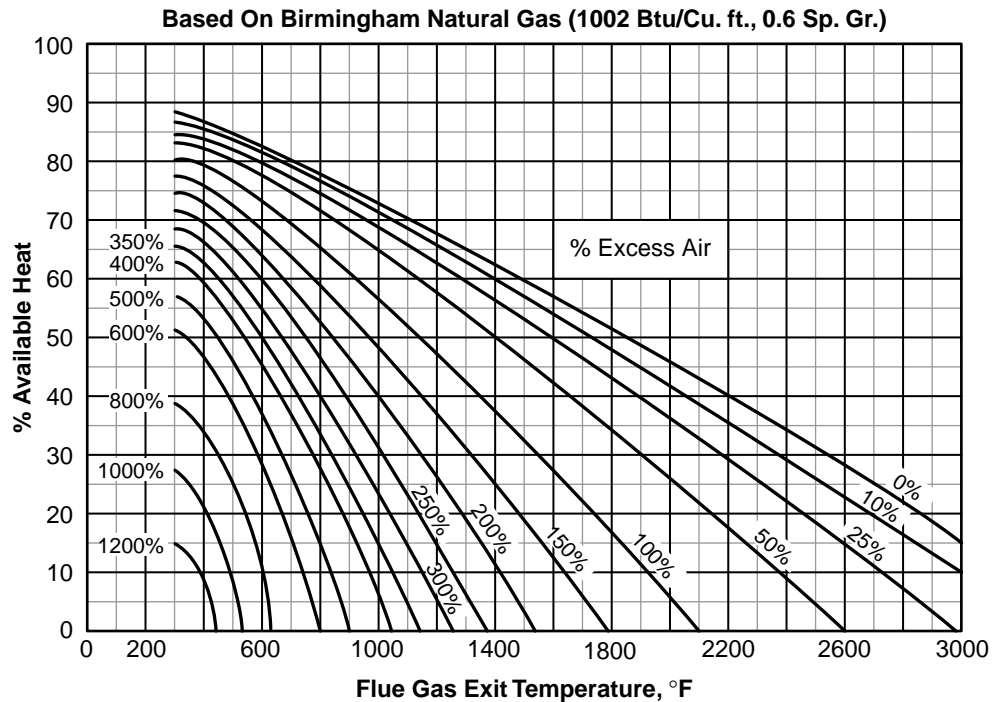

Tech Notes

Summary of Fuel-Air Ratio Control Systems for Nozzle Mixing Burners

Control System	System Cost*	Required Gas Pressure**	Control Mode		If backpressure fluctuates, does system maintain constant:		On multiple burner zones, if one is shut off, do the others hold their ratio?
			Hi-Low	Modulating	Firing Rate?	Fuel-Air Ratio?	
On-ratio, linked valve	I	L	•		No	***	No
On-ratio, characterized valve	M	L to M	•	•	No	***	No
On-ratio, cross connected proportionator	M	H	•	•	No	Yes	Yes
On-ratio, cross connected proportionator & bleeder	M	L to M	•	•	No	Yes	Yes
On-ratio, electronic	E	M	•	•	Yes	Yes	No
Excess air, fuel-only control	I	M	•	•	No	***	No
Excess air, biased proportionator	M	H	•	•	No	No	Yes
Excess air, throttled impulse	M	H	•	•	No	Yes†	Yes

* I=Inexpensive, M=Moderate, E=Expensive

** L=Low, M=Moderate, H=High

*** Depends on air and gas pressures at burner. See sheets for individual systems.

† If bleeder vent is connected to combustion chamber.

Tech Notes

Nozzle Mixing Burners

Ratio Control Using Proportioning (Linked) Fixed Port Valves

Operating Principle

Air and gas passages in the burner are the fixed resistances in the system. Control valves in the air and gas lines are the variable resistance. The two valves are connected by linkages to a common drive motor so that, in theory, they open and close in proportion, maintaining a fixed air-gas ratio over the system's turndown range.

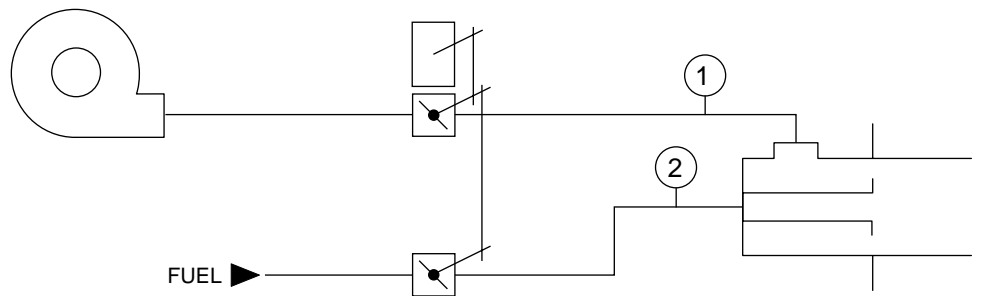

Advantages

- Valve operation can be readily understood—confidence builder for persons unfamiliar with control systems.
- Working parts are visible—little chance that a hidden defect is present.
- Can be used with low gas supply pressures. If a large enough gas valve is selected, the pressure required is only a little higher than the burner gas nozzle pressure (2 in above figure).
- Inexpensive.

Disadvantages

- Differences in valve characteristic curves make it difficult or impossible to hold a fixed gas-air ratio across the entire turndown range. The system is best limited to high-low control.
- Unless air and gas pressures at the burner (1 and 2 in the figure on page 85) are equal, unforeseen changes in combustion chamber pressure will cause the burner to shift off-ratio according to the table below:

If Air Pressure Is	And Chamber Pressure		
	Goes More Positive (+), Then:	Stays The Same (o), Then:	Goes More Negative (-), Then:
Higher than gas pressure	Burner goes leaner	No change	Burner goes richer
Same as gas pressure	No change	No change	No change
Lower than gas pressure	Burner goes richer	No change	Burner goes leaner

If air pressure at the burner is higher than the gas pressure (this is usually the case), they can be made equal by installing a limiting orifice valve between the gas control valve and burner and adjusting it until pressure (2) equals pressure (1). However, this negates one of the advantages of linked valve systems—the low gas pressure requirement.

- If the air supply becomes starved due to a dirty blower wheel or a plugged filter, the system will go rich. The gas valve responds only to the mechanical linkage, not to air flow changes.
- If multiple burners are controlled by a single set of linked valves, and the fuel flow to one burner is throttled back manually or shut off entirely, that fuel will go to the other burners, forcing them to run rich. In addition to the safety hazard this presents, it makes multiple burners tedious to set up. Any gas adjustment made to one burner upsets the settings of the other burners in the zone.

Tech Notes

Nozzle Mixing Burners

Ratio Control Using Proportioning (Adjustable Characteristic) Valves

Operating Principle

Air and gas passages in the burner are the fixed resistances in the system. Control valves are the variable resistances and are connected in tandem to a common drive motor. Because it is practically impossible to get two fixed port valves to track together over their turndown range, at least one of the valves is fitted with an adjustable screw rack which makes the valve open faster or slower than the linkage calls for. This permits the valve's flow curve to be adjusted to more closely match that of the fixed port valve.

Advantages

- Valve operation can be readily understood—confidence builder for persons unfamiliar with control systems.
- Working parts are visible—little chance that a hidden defect is present.
- Can be used with low gas supply pressures.
- Can be used with proportioning or high-low control systems.

Disadvantages

- Adjustable characteristic valves are usually expensive.
- Time consuming to set up. Most screw racks contain 8 to 12 adjustment points, which must be individually set when the burner is commissioned.
- Unless air and gas pressures at the burner (1 and 2 in the figure below) are equal, unforeseen changes in combustion chamber pressure will cause the burner to shift off-ratio according to the table on page 88.

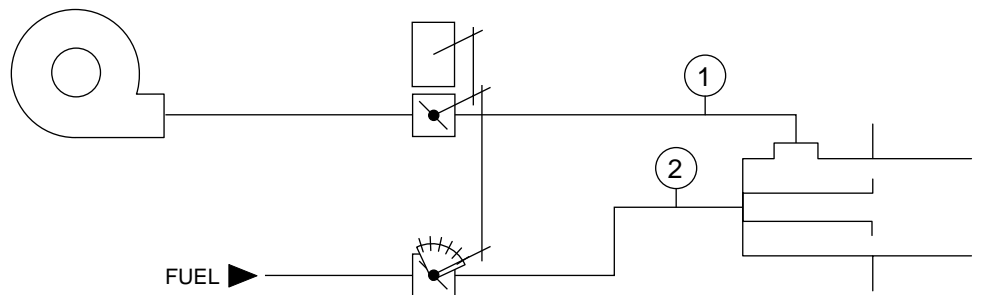

Disadvantages (continued)

If Air Pressure Is	And Chamber Pressure		
	Goes More Positive (+), Then:	Stays The Same (o), Then:	Goes More Negative (-), Then:
Higher than gas pressure	Burner goes leaner	No change	Burner goes richer
Same as gas pressure	No change	No change	No change
Lower than gas pressure	Burner goes richer	No change	Burner goes leaner

If air pressure at the burner is higher than the gas pressure (this is usually the case), they can be made equal by installing a limiting orifice valve between the gas control valve and burner and adjusting it until pressure (2) equals pressure (1). However, this negates one of the advantages of linked valve systems—the low gas pressure requirement.

- If the air supply becomes starved due to a dirty blower wheel or a plugged filter, the system will go rich. The gas valve responds only to the mechanical linkage, not to air flow changes.
- If multiple burners are controlled by a single set of linked valves, and the fuel flow to one burner is throttled back manually or shut off entirely, that fuel will go to the other burners, forcing them to run rich. In addition to the safety hazard this presents, it makes multiple burners tedious to set up. Any gas adjustment made to one burner upsets the settings of the other burners in the zone.

Tech Notes

Nozzle Mixing Burners

Ratio Control Using Cross-Connected Proportionators

Operating Principle

Burner air passage is fixed resistance for air flow. Gas passages in the burner are usually too large to serve as the fixed resistance, so a limiting orifice valve is installed at the gas inlet. At setup, this valve is adjusted to provide the correct gas flow when gas pressure (2) is equal to air pressure (1). Low fire gas-air ratio is set with spring in Proportionator.

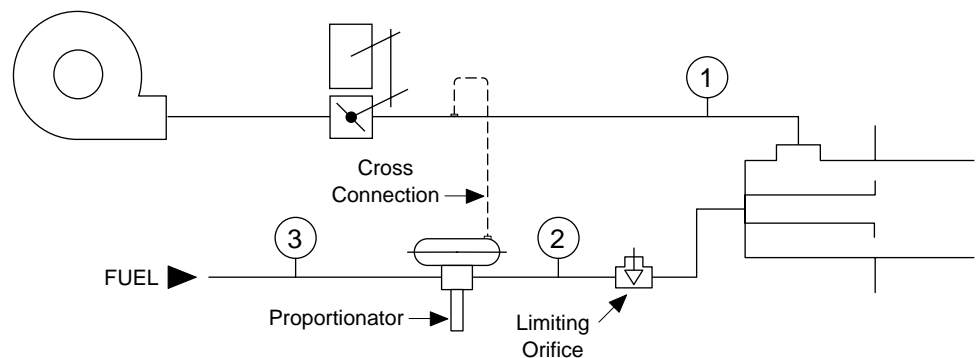

Advantages

- Easy to set up. Once high and low fire ratios are set, everything in between is taken care of.
- Can be used with proportioning or high-low control systems.
- No problem with mismatched valve flow curves. Proportionator is slave to air valve and automatically matches its characteristic curve.
- Fuel-air ratio is unaffected by unforeseen changes in combustion chamber pressure.
- Although air starvation due to a plugged filter or dirty blower wheel will cause a loss in firing capacity, it will not cause the system to go rich. The proportionator automatically reduces fuel flow as the air flow drops off.
- On multiple burner systems fed from a single air control valve and proportionator, changing or shutting off the fuel flow to one burner will not upset the fuel flow to the others. This makes initial setup easier and eliminates the hazard of burners in a zone going rich because one of them has been misadjusted or shut off.
- If proportionator permits, this system can be converted to an excess air system (see page 95) with a simple proportionator spring adjustment.

Disadvantages

- Requires higher gas pressures. Gas pressure at (3) in the figure on page 89 must equal air pressure at (1) plus gas pressure drop through proportionator valve.
- Operating principles of proportionator are poorly understood, especially in oven and air heating industry; operators don't know how to set up systems.
- Internal working of proportionator can't be seen. Operators don't know if it's working correctly and, as a result, are afraid of it.

Tech Notes

Nozzle Mixing Burners

Ratio Control Using Cross-Connected Proportionator With Bleed Fitting

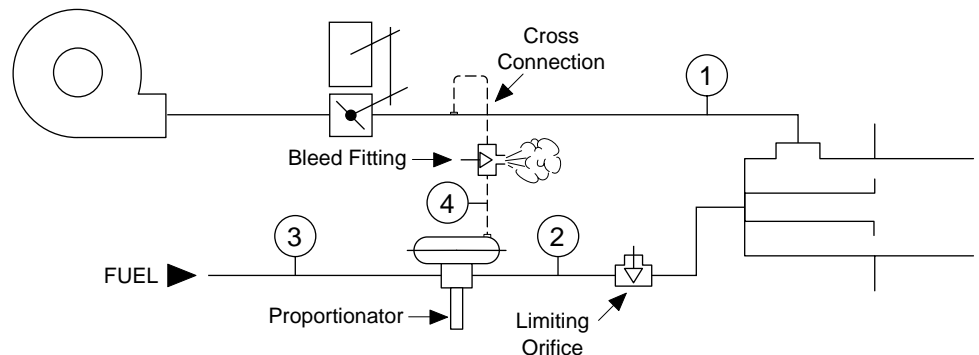

Operating Principle

Used where proportionator system is desired, but where gas pressure at (3) is insufficient to make a conventional proportionator system work (see page 89). This set-up is also used where the loading pressure on the proportionator is equal to or higher than the maximum inlet gas pressure the proportionator can tolerate. An adjustable bleed fitting—basically a needle in a tee—reduces the loading pressure (4) on the proportionator to a pressure at least 2" w.c. lower than the inlet gas pressure (3). This permits the proportionator to respond to changes in air loading pressure (1) over the entire turndown range.

If, for example, high fire air pressure (1) is 20" w.c., but gas supply (3) is only 13" w.c., the bleeder could be set to bleed off 50% of the air loading pressure, producing a pressure of 10" w.c. at (4) and (2).

Advantages

Same as the conventional proportionator system (see page 89), except that combustion chamber pressure fluctuations will cause the system to go off-ratio. Can be compensated by connecting the vent of the bleed fitting to the combustion chamber.

Disadvantages

- Same as the conventional proportionator system (see page 89), except that high inlet gas pressure is no longer required.
- Bleed fittings contain small orifices which are susceptible to plugging by dirt. Filtered combustion air will alleviate the problem, but bleeders will always require frequent maintenance attention and they are subject to unauthorized tampering.

Tech Notes

Nozzle Mixing Burners Ratio Control Using Electronic Controllers

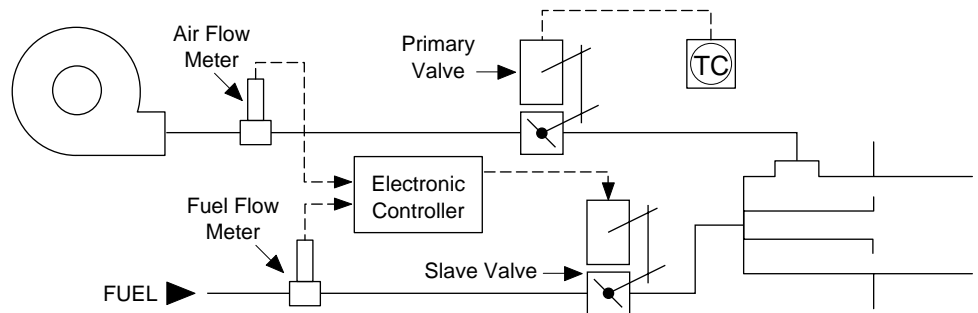

Operating Principle

For all of its sophistication, a variation of the linked valve system. In this case, the linkage is electronic instead of mechanical. This system is also known as a “mass flow” control system, although this a misnomer—the flow signals fed to the controller are related either to pressure differential or to flow velocity.

The air and fuel lines each contain a motor-driven control valve and a flow metering device (orifice plate & ΔP transmitter, turbine meter, vortex-shedding flowmeter, etc.) One of the control valves is the primary valve, driven by the temperature controller. The second valve is slaved to the first through the electronic ratio controller.

Flow meters in the air and fuel lines feed signals proportional to flow to the controller. The controller compares the signals and, if they are out of ratio, sends a correcting signal to the slave valve, which then alters its flow to restore the desired air-fuel ratio.

Advantages

- Extremely high accuracy inherent to electronic systems.
- Can be integrated with master computer to control burner, as well as provide fuel consumption data.
- If controller can be reprogrammed, can be reconfigured as an excess air system.
- Will not allow the burner to go rich if air starvation occurs.
- Provided that air and fuel supply pressures are adequate, will maintain a predetermined firing rate regardless of combustion chamber backpressure fluctuations. This is the only system that will do so.

Disadvantages

- Most expensive of all the ratio control systems.
- No matter how sophisticated the electronics, the accuracy of the system is no better than the flow-sensing elements. If orifice plates are used to measure flows, accuracy degrades rapidly at turndown ratios greater than 4:1 unless systems are individually calibrated in the field.
- On a multiple burner system, turning the fuel of one burner down or off will cause the others to run rich—this system will try to maintain a gas flow proportional to airflow, regardless of where the gas has to go.

Tech Notes

Nozzle Mixing Burners

Excess Air Operation By Controlling Fuel Only

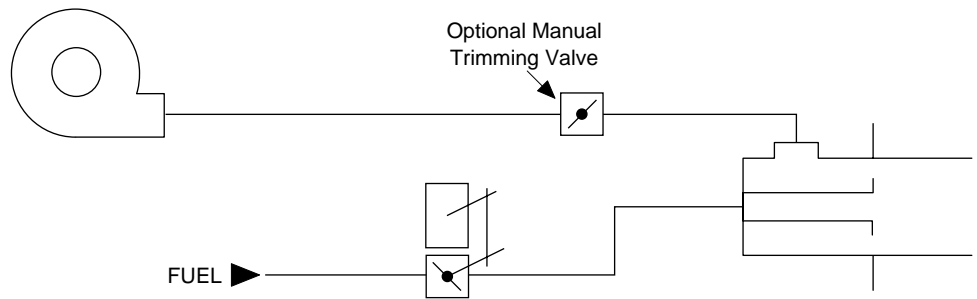

Operating Principle

This system is known as the “fuel only control”, “fixed air” or “wild air” system; it is the simplest of all excess air systems. A motor-driven valve is placed in the fuel line, while the air has no flow controller—a manual trimming valve might be installed for servicing or limiting the high fire flow.

Advantages

- Low cost.
- Permits attainment of the maximum excess air capability of the burner.
- Suitable for high-low or proportioning control.

Disadvantage

- If multiple burners are controlled from a single fuel valve, reducing or shutting off the fuel flow to one of them causes the others to go richer.

Tech Notes

Nozzle Mixing Burners

Excess Air Operation With Biased Proportionator

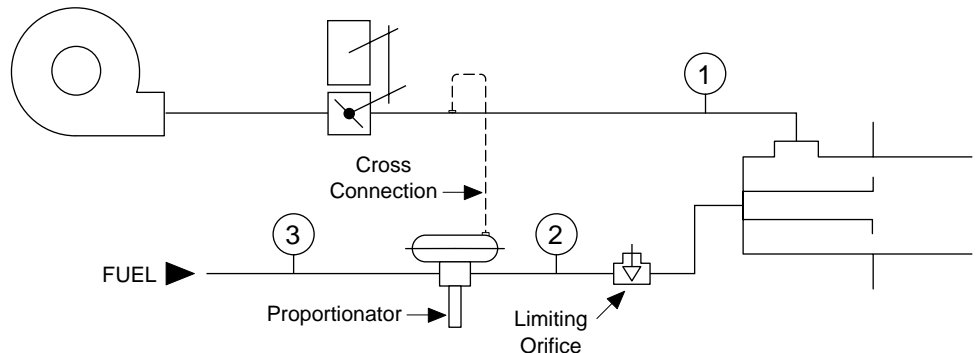

Operating Principle

System installation is identical to conventional proportionator system (see page 89), but requires a proportionator whose spring can be adjusted to produce a significant negative bias. System is customarily set up to operate near stoichiometric ratio at high fire. As air valve closes, the proportionator—with its negative spring bias—causes fuel flow to decrease even more rapidly, producing increasing amounts of excess air.

Advantages

- Better fuel economy than fuel-only control excess air system (see page 94).
- Suitable for high-low or proportioning control.
- Unlike fuel-only control system, turning down or shutting off the gas flow to one burner in a multi-burner system will not cause the others to go rich.

Disadvantages

- Not capable of excess air rates as high as the fuel-only control system.
- More expensive than fuel-only control system.

Tech Notes

Nozzle Mixing Burners

Excess Air Operation With Throttled Impulse (Adjustable Bleed) To Proportionator

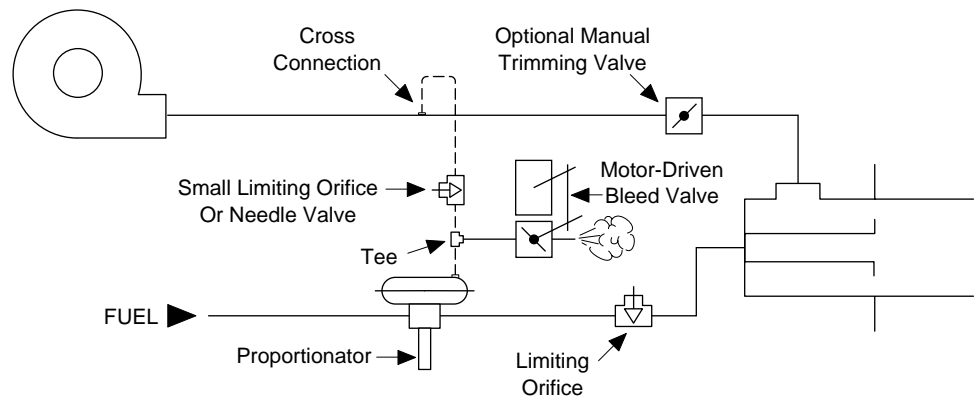

Operating Principle

A variation on the cross-connected proportionator system (see page 89). There is no control valve in the combustion air line. Instead, the firing rate control valve is placed in the bleed leg of a tee in the impulse line to the proportionator, and the linkage is adjusted to make the bleed valve reverse-acting; i.e., the valve closes when the temperature controller calls for heat. The limiting orifice or needle valve in the loading line is closed partway to restrict air flow through the impulse line—this insures that the motor-driven bleed valve is able to control over its entire range.

Advantage

- Of all the excess air control systems, this one probably has the best combination of sensitivity and a wide operating range.

Disadvantages

- Like fixed bleed orifice systems, this control system can be upset by accumulations of airborne dirt and unauthorized tampering.
- The only valve proven suitable as a motor-driven bleed valve is the North American 3/8" Adjustable Port Valve. Even 3/8" motorized oil valves—whether Eclipse's, Hauck's or North American's—lack the sensitivity for this application.

Tech Notes

Backpressure Compensation System For Cross-Connected Nozzle Mix Burner Systems

Purpose: To maintain a constant burner firing rate and fuel-air ratio regardless of random fluctuations in combustion chamber backpressure.

Method: Hold a constant differential pressure between point "B" (upstream of main air control valve) and point "D" (combustion chamber), even if pressure at point "D" varies. This is done by putting two air control valves in series, one responding to the temperature controller, the other to the differential pressure between points "B" and "D".

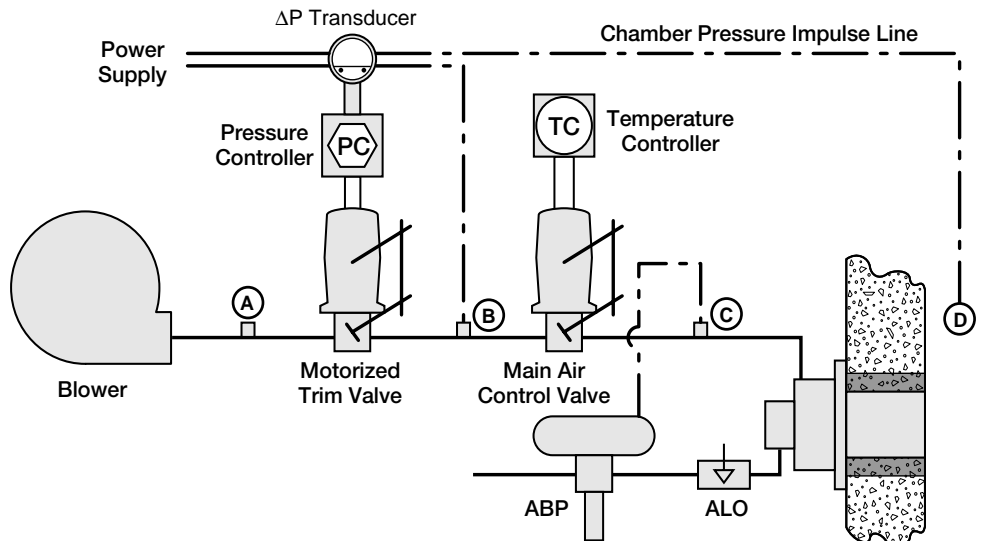

Example: Assume backpressure will vary uncontrollably between 0 & 10" w.c.
 Assume burner ΔP is 10" w.c. @ high fire, 1" w.c. @ low fire.
 Main air control valve ΔP is 5" w.c. @ high fire.
 Blower develops 30" w.c. static pressure.

Firing Rate	Back Press	Static Pressures, "W.C.				Differential Pressures, "W.C.					Must Be Constant B-D
		A	B	C	D	A-B	B-C	C-D	A-C	A-D	
High	0" w.c.	30	15	10	0	15	5	10	20	30	15
	5" w.c.	30	20	15	5	10	5	10	15	25	15
	10" w.c.	30	25	20	10	5	5	10	10	20	15
Low	0" w.c.	30	15	1	0	15	14	1	29	30	15
	5" w.c.	30	20	6	5	10	14	1	24	25	15
	10" w.c.	30	25	11	10	5	14	1	19	20	15

Tech Notes

Conversion Factors For Emissions Calculations

Preparing emissions estimates for environmental authorities can be difficult because they often ask for emissions expressed in units not available through existing data. Here are the conversion procedures for some of the more commonly-used measurement systems:

- 1) **ppm at 3% O₂ (15% excess air) in dry flue gases to lb./million Btu**
 $(\text{ppm})(F_3) = \text{lb./million Btu}$

Values of multiplier F₃ for various fuels and emissions

Various Fuels	NO _x Measured As NO ₂	CO	Aldehydes, Measured As Formaldehyde	Unburned Hydrocarbons, Measured As:		CO ₂	SO ₂
				Methane	Propane		
Birmingham Nat. Gas*	.001187	.000722	.000781	.000416	.001147	.001147	.001672
Propane	.001185	.000721	.000780	.000415	.001146	.001146	.001669
Butane	.001212	.000735	.000798	.000424	.001172	.001172	.001707
#2 Oil**	.001317	.000801	.000867	.000461	.001273	.001273	.001854

- 2) **lb./million Btu to ppm at 3% O₂ (15% excess air) in dry flue gases**

$$(\text{lb./million Btu})(f_3) = \text{ppm @ 3\% O}_2, \text{ dry}$$

Values of multiplier f₃ for various fuels and emissions

Various Fuels	NO _x Measured As NO ₂	CO	Aldehydes, Measured As Formaldehyde	Unburned Hydrocarbons, Measured As:		CO ₂	SO ₂
				Methane	Propane		
Birmingham Nat. Gas*	842	1385	1280	2404	872	872	598
Propane	844	1387	1282	2410	873	873	599
Butane	825	1361	1253	2358	853	853	586
#2 Oil**	759	1248	1153	2169	786	786	539

- 3) **ppm at 0% O₂ in dry flue gases to lb./million Btu**
 $(\text{ppm})(F_0) = \text{lb./million Btu}$

Values of multiplier F₀ for various fuels and emissions

Various Fuels	NO _x Measured As NO ₂	CO	Aldehydes, Measured As Formaldehyde	Unburned Hydrocarbons, Measured As:		CO ₂	SO ₂
				Methane	Propane		
Birmingham Nat. Gas*	.001017	.000617	.00067	.000356	.000983	.000983	.001432
Propane	.001018	.000619	.00067	.000356	.000984	.000984	.001434
Butane	.001042	.000634	.000686	.000365	.001007	.001007	.001468
#2 Oil**	.001133	.00069	.000746	.000397	.001096	.001096	.001596

* 1002 Gross Btu/cubic foot, 8.48 Cubic feet dry flue products at stoichiometric ratio.

** Calculated as heptadecane, C₁₇H₃₆, 19,270 Gross Btu/lb.

4) **lb./million Btu to ppm at 0% O₂ in dry flue gases**

$$(\text{lb./million Btu})(f_0) = \text{ppm @ 0\% O}_2, \text{ dry}$$

Values of multiplier f_0 for various fuels and emissions

Various Fuels	NO _x Measured As NO ₂	CO	Aldehydes, Measured As Formaldehyde	Unburned Hydrocarbons, Measured As:		CO ₂	SO ₂
				Methane	Propane		
Birmingham Nat. Gas*	983	1621	1493	2809	1017	1017	698
Propane	982	1616	1493	2809	1016	1016	697
Butane	960	1577	1458	2740	983	983	681
#2 Oil**	883	1449	1340	2519	912	912	627

5) **ppm at 3% O₂ or 0% O₂ in dry flue gases to lb./year**

First, calculate lb./million Btu with Step 1 or 3 on the first page.

Then convert to lbs./year with the following relationship:

$$(\text{lb./million Btu}) (\text{Maximum Burner Input, million Btu/hr.}) (\text{operating hrs./year}) = \text{lb./year}$$

6) **lb./year to ppm at 3% O₂ or 0% O₂ in dry flue gases**

$$\text{lb./year} \div \text{operating hrs./year} \div \text{Maximum Burner Input, million Btu/hr.} = \text{lb./million Btu}$$

Convert lb./million Btu to ppm with Step 2 or 4.

7) **ppm at 3% O₂ or 0% O₂ in dry flue gases to gm/Nm³**

$$(\text{ppm})(G) = \text{gm/Nm}^3$$

Values of multiplier G for various emissions

Emission	NO _x Measured As NO ₂	CO	Aldehydes, Measured As Formaldehyde	Unburned Hydrocarbons, Measured As:		CO ₂	SO ₂
				Methane	Propane		
G	.002031	.001235	.001341	.000716	.001969	.001965	.002861

8) **gm/Nm³ to ppm at 3% O₂ or 0% O₂ in dry flue gases**

$$(\text{gm/Nm}^3)(g) = \text{ppm}$$

Values of multiplier g for various emissions

Emission	NO _x Measured As NO ₂	CO	Aldehydes, Measured As Formaldehyde	Unburned Hydrocarbons, Measured As:		CO ₂	SO ₂
				Methane	Propane		
g	492.4	809.7	745.7	1396.6	507.9	508.9	349.5

* 1002 Gross Btu/cubic foot, 8.48 Cubic feet dry flue products at stoichiometric ratio.

** Calculated as heptadecane, C₁₇H₃₆, 19,270 Gross Btu/lb.

Tech Notes

Correcting Emissions Readings to 3% O₂ or 11% O₂ Basis

Many environmental authorities, including the U.S. EPA and several European agencies, require that gaseous pollutants, like NO_x and CO, be reported in ppm (parts per million by volume) corrected to a based of 3% excess O₂—or 15% excess air—in the flue gases. Japan, on the other hand, customarily uses a base of 11% O₂.

Emission readings taken at different oxygen levels can be easily converted to a standard base using a multiplier:

$$\text{ppm}_{\text{corrected}} = \text{ppm}_{\text{test}} \times \text{multiplier}$$

The multiplier is calculated from the oxygen reading taken during the test and the base oxygen reading required by the regulation:

$$\text{multiplier} = \frac{21 - \% \text{O}_2 \text{ base}}{21 - \% \text{O}_2 \text{ test}}$$

For your convenience, a table of multipliers is presented to the right.

%O ₂	Multiplier For:	
	3%O ₂	11%O ₂
0	.86	.48
1	.9	.5
2	.95	.53
3	1	.56
4	1.06	.59
5	1.13	.63
6	1.2	.67
7	1.29	.71
8	1.38	.77
9	1.5	.83
10	1.64	.91
11	1.8	1
12	2.0	1.11
13	2.25	1.25
14	2.57	1.43
15	3.0	1.67
16	3.6	2
17	4.5	2.5
18	6	3.33
18.5	7.2	4
19	9	5
19.5	12	6.67
20	18	10
20.2	22.5	12.5
20.4	30	16.67
20.6	45	25
20.8	90	50

Tech Notes

Recuperator Efficiency: Fuel Savings & Effectiveness

Percent Fuel Savings

There are two commonly-used methods for figuring recuperator efficiency: percent fuel savings and percent effectiveness.

Percent savings is calculated by this relationship:

$$\% \text{ Savings} = \left(\frac{\% \text{ Available Heat Less Recuperator}}{\% \text{ Available Heat With Recuperator}} \right) \times 100$$

Because available heat figures vary with the composition of the fuel and the amount of excess air, one supplier's fuel savings data may be different from another's by one or two percentage points. More often than not, the tables will be based on natural gas at 10% excess air.

Percent Effectiveness

Percent effectiveness measures the inherent heat transfer capabilities of the recuperator without regard to fuel composition or fuel/air ratio:

$$\% \text{ Effectiveness} = \left(\frac{\text{Combustion Air Temp Leaving Exchanger} - \text{Combustion Air Temp Entering Exchanger}}{\text{Flue Gas Temp Entering Exchanger} - \text{Combustion Air Temp Entering Exchanger}} \right) \times 100$$

Basically, it compares the actual rise in combustion air temperature to the maximum that could possibly be achieved (combustion air preheated to the same temperature as the incoming flue gases). Since the maximum is unattainable, effectiveness is always less than 100%.

The graph on page 102 relates combustion air temperature to flue gas temperature and recuperator effectiveness.

To predict air preheat, read up from the flue gas temperature to the line representing the effectiveness of the exchanger, then left to air preheat.

Figure 1:
Heat Exchanger
Effectiveness Curves
Based on Combustion Air
Entering at 60° F.

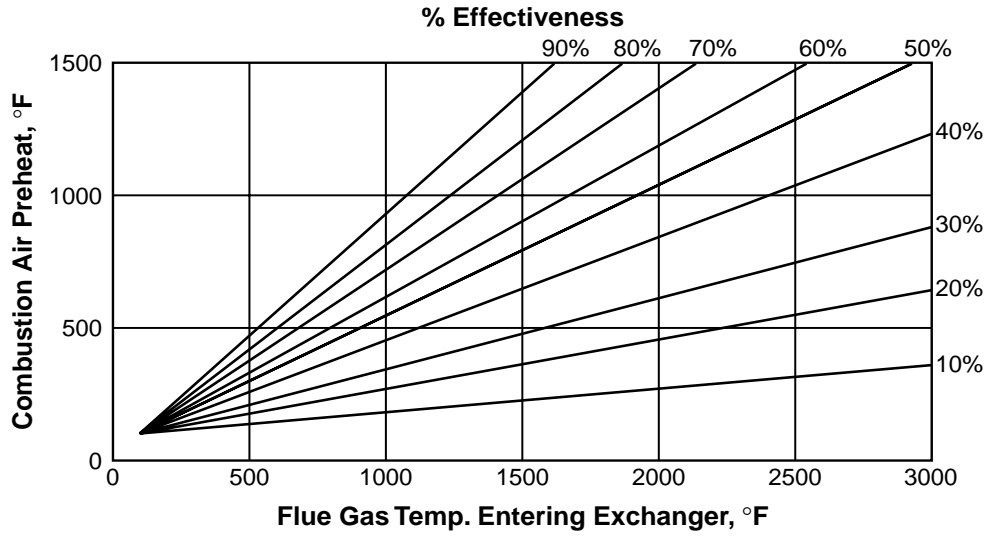

NFPA Requirements for Gas Burner Systems

Reference: NFPA 86 – Ovens and Furnaces, 1999 Edition

General Remarks:

The schematic and notes on the following page condense the gas burner system requirements of National Fire Protection Association (NFPA) 86 into an easy-to-use format. They should provide most of the engineering information required to lay out burner air and gas trains. Numbers in parentheses refer to the applicable paragraphs of the standard.

In addition to the requirements shown on the schematic, NFPA 86 also requires that the combustion control system have the following features:

- 1) Safety control circuits must be single phase, one side grounded, with all breaking contacts in the “hot”, ungrounded, circuit protected line not exceeding 120V. (5-2.11)
- 2) Prior to energizing spark or lighting pilot, a timed pre-purge of at least four standard cubic feet of air per cubic foot of heating chamber volume is required (5-4.1).
 - a) Airflow must be proven & maintained during the purge.
 - b) Safety shutoff valve must be closed and when the chamber input exceeds 400,000 Btu/hr (117 kW) it must be proved and interlocked.
- 3) Exceptions to a re-purge are allowed for momentary shutdowns if (any one): (5-4.1.5)
 - a) Each burner is supervised, each has safety shutoff valves, and the fuel accumulation in the heating chamber can not exceed 25% of lower explosive limit.
 - b) Each burner is supervised, each has safety shutoff valves, and at least one burner remains on in same chamber.
 - c) The chamber temperature is more than 1400°F (760°C).
- 4) Exception to the pre-purge is allowed for explosion resistant radiant tube systems. (5-4.1.4)
- 5) All safety interlocks must be connected in series ahead of the safety shutoff valves. Interposing relays are allowed when the required load exceeds the rating of available safety contacts or where safety logic requires separate inputs, AND the contact goes to a safe state on loss of power, AND each relay serves only one interlock. (5-2.7)
- 6) Any motor starters required for combustion must be interlocked into the safety circuit. (5-6.3)
- 7) A listed manual reset excess temperature limit control is required except where the system design can not exceed the maximum safe temperature. (5-16)
- 8) The user has the responsibility for establishing a program of inspection, testing, and maintenance with documentation performed at least annually. (5-2.5.2)

The scope of NFPA 86 extends to all the factors involved in the safe operation of ovens and furnaces, and anyone designing or building them should be familiar with the entire standard. Copies can be purchased from:

The National Fire Protection Association
1 Batterymarch Park
Quincy, MA 02269-9101
800-344-3555
508-895-8300 if outside U.S.
www.nfpa.org

Piping Schematic

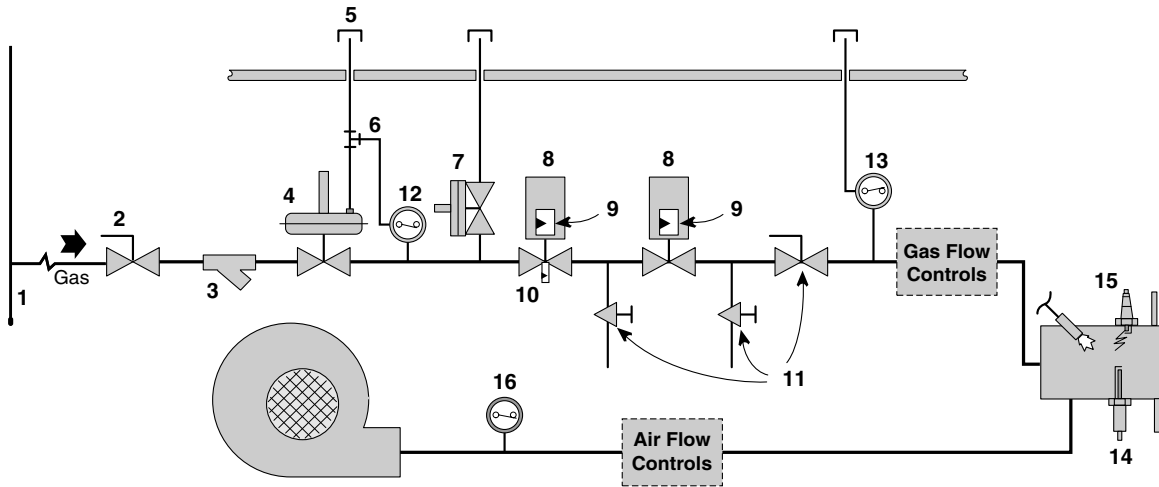

Item	Description	Reference Paragraph
1	Facility to install drip leg or sediment trap for each fuel supply line. Must be a minimum of 3" long.	4-2.4.4
2	Individual manual shutoff valve to each piece of equipment. 1/4 turn valves recommended.	4-2.4.1
3	Filter or strainer to protect downstream safety shutoff valves.	4-2.4.3
4	Pressure regulator required wherever plant supply pressure exceeds level required for proper burner function or is subject to excessive fluctuations.	4-2.4.5.1
5	Regulator vent to safe location outside the building with water protection & bug screen. <ul style="list-style-type: none"> • Vent piping can terminate inside the building when gas is lighter than air, vent contains restricted orifice, and there is sufficient building ventilation. • Vent piping not required for lighter than air gases at less than 1 psi, vent contains restricted orifice, and there is sufficient ventilation. Vent piping not required for ratio regulator. 	4-2.4.5.2
6	Gas pressure switches may be vented to regulator vent lines if backloading won't occur.	4-2.4.5.5
7	Relief valve required if gas pressure at regulator inlet exceeds rating of safety shutoff valve.	5-7.1.7
8	Two listed* safety shutoff valves required for each main and pilot gas burner system. A single valve can be used for explosion resistant radiant tube systems.	5-7.2.1
9	Position indication (not proof-of-closure) required on safety shutoff valves to burners or pilots in excess of 150,000 Btu/hr (44 kW).	5-7.1.8
10	For capacities over 400,000 Btu/hr (117 kW) at least one safety shutoff valve must have a closed position switch to interlock with the pre-purge.	5-7.2.2
11	Permanent and ready means for checking leak tightness of safety shutoff valves.	5-7.2.3
12	Listed* low gas pressure switch (normally open, makes on pressure rise).	5-8.1
13	Listed* high gas pressure switch (normally closed, breaks on pressure rise).	5-8.2
14	Flame Supervision: <ul style="list-style-type: none"> • Piloted burners <ul style="list-style-type: none"> - <i>Continuous pilot</i>: Two flame sensors must be used, one for the pilot flame and one for the main burner flame. - <i>Intermittant pilot</i>: Can use a single flame sensor for self-piloted burners (from same port as main, or has a common flame base and has a common flame envelope with the main flame). - <i>Interrupted pilot</i>: A single flame sensor is allowed. • Line, Pipe, Radiant burners <ul style="list-style-type: none"> - If the burners are adjacent and light safely and reliably from burner to burner, then a single sensor is allowed if it is located at the farthest end from the source of ignition. 	5-9 5-9.2.1 5-9.2.2
15	Spark Ignition: <ul style="list-style-type: none"> • Except for explosion resistant radiant tube systems, direct spark igniters must be shut off after main burner trial-for-ignition. • If a burner must be ignited at reduced input (forced low fire start), an ignition interlock must be provided to prove control valve position. • Trial-for-ignition of the pilot or main must not exceed 15 seconds. An exception is allowed where fuel accumulation in the heating chamber can not exceed 25% of the lower explosive limit and the authority having jurisdiction approves a written request for extended time. 	5-15.2 5-15.1 5-4.2.2
16	Listed* combustion air flow or pressure proving switch (normally open, makes on pressure rise).	5-6.4

*Underwriters Laboratory (UL) listing is accepted throughout the United States. Listed products can be found in the UL Gas and Oil Equipment Directory, available from Underwriters Laboratory, Inc. Publications Stock, 333 Pfingsten Road, Northbrook, IL 60062-2096. Factory Mutual (FM) listed equipment is also acceptable in most jurisdictions and can be found in the FM Approval Guide available from Factory Mutual Research Corporation, 115 Boston-Providence Turnpike, Norwood, MA 02062.

IRI Requirements For Gas Burner Systems

Reference: IM.4.2.0 & IM.4.2.1, June 1, 2000

General Remarks:

These schematic and notes condense the gas burner system requirements of GE Global Asset Protection Services - Industrial Risk Insurers (IRI) publications "IM.4.2.0 OVENS AND FURNACES - NFPA 86-1999" and "IM.4.2.1 HEAT TREAT FURNACES WITH INTERNAL QUENCH TANKS". They should provide most of the engineering information required to lay out burner air and gas trains. IRI follows the requirements of NFPA 86 but makes additional clarifications and changes for increased safety.

In addition to the requirements shown on the following schematic, IRI also requires that the combustion control system have the following features. Numbers in parenthesis reference the paragraphs in IM.4.2.0, IM.4.2.1, and NFPA 86.

- 1) **NFPA:** Safety control circuits must be single phase, one side grounded, with all breaking contacts in the "hot", ungrounded, circuit protected line and not exceed 120V. **IRI:** Any time delay used to avoid nuisance shutdowns from momentary power fluctuations cannot exceed 5 seconds and any timer must not be adjustable above this maximum. (5-2)
- 2) **NFPA:** Prior to energizing spark or lighting pilot, a timed pre-purge of at least four standard cubic feet of air per cubic foot of heating chamber volume is required. **IRI:** Any adjustable purge timer must clearly show its setting, have limited access, and be periodically inspected. Any employee with access must be trained on its setting and consequences if not set properly. (5-4.1.2)
 - a. **NFPA:** Airflow must be proven and maintained during the purge. **IRI:** The location of pressure switch sensing points must be analyzed against all other conditions (such as dirt accumulation and damper positions in the system) to assure it will truly prove the required airflow. (5-4.1.2.1)
 - b. **NFPA:** Where the capacity exceeds 400,000 Btu/hr (117kW) at least one of the safety shutoff valves must be proved closed and interlocked to the purge. **IRI:** Both safety shutoff valves shall be proved closed and interlocked. (5-7.2.2)
- 3) **IRI:** The trial for ignition for pilots or main burners must not exceed 10 seconds. (5-4.2.1, 5-4.2.2)
Directly control the spark from a listed flame safeguard. (5-2.3)
- 4) **NFPA:** All safety interlocks must be connected in series ahead of the safety shutoff valves. Interposing relays are allowed when the required load exceeds the rating of available safety contacts, or where the safety logic requires separate inputs, AND the contact goes to safe state on loss of power, AND each relay serves only one interlock. **IRI:** An interposing relay can be powered by more than one safety limit if the safety shutoff valves derive power in series through the limits. When one limit opens then the fuel is shutoff to all burners that use the interposing relay as a permissive. (5-2.7)
- 5) **NFPA:** Any motor starters, circulation, and exhaust fans required for safe combustion or purge must be proven. (5-6.3) **IRI:** Use a rotation switch if pressure switches or sail switches are not suitable. (5-5.1)
- 6) **NFPA-IRI:** A listed manual reset excess temperature limit control is required except where the system design cannot exceed the maximum safe temperature. (5-16)
- 7) **NFPA-IRI:** Piping and electrical schematics of the proposed system must be submitted to the local IRI office in whose jurisdiction the system will be located. Drawings must include the various device settings, switch positions, configurations and notes on options. Stamped approval is required before construction begins. (1-4)
- 8) **NFPA-IRI:** The user has the responsibility to establish a program of inspection, testing, and maintenance with documentation performed at least annually. (5-2.5.2)

Piping Schematic

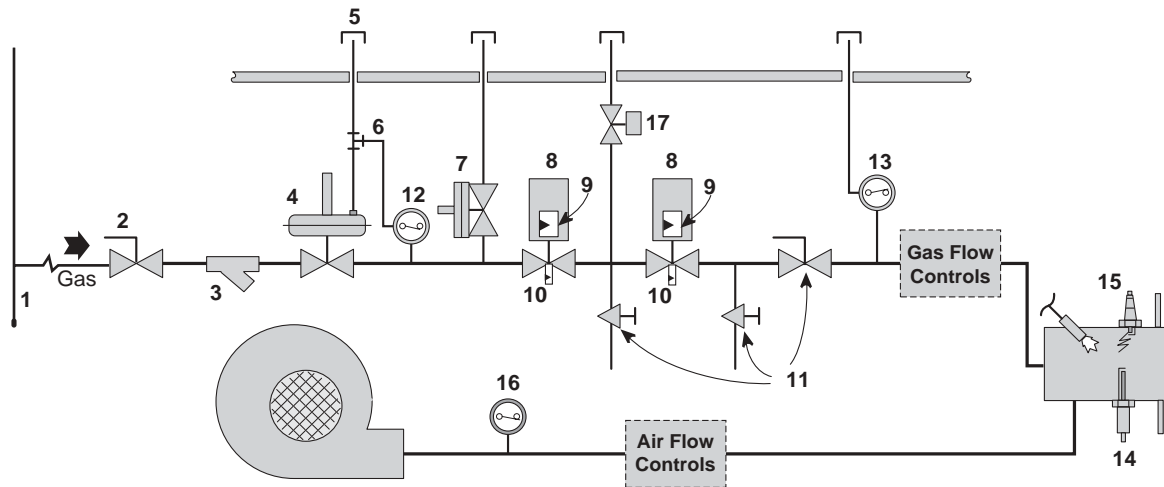

Item	Description	Reference Paragraph
1	Facility to install drip leg or sediment trap for each fuel supply line. Must be a minimum of 3" long.	4-2.4.4
2	Individual manual shutoff valve to each piece of equipment. 1/4 turn valves recommended. Must be in an accessible location near the floor.	4-2.4.1
3	Filter or strainer to protect downstream safety shutoff valves.	4-2.4.3
4	Pressure regulator required wherever plant supply pressure exceeds level required for proper burner function or is subject to excessive fluctuations.	4-2.4.5.1
5	Regulator vent to safe location outside the building with water protection & bug screen. <ul style="list-style-type: none"> • Vent piping can terminate inside the building when gas is lighter than air, vent contains restricted orifice, and there is sufficient building ventilation, where there are high clearances between the equipment and roof and there are no ignition sources. • Vent piping not required for lighter than air gases at less than 1 psi, vent contains restricted orifice, and there is sufficient ventilation. Vent piping not required for ratio regulator. 	4-2.4.5.2
6	Gas pressure switches may be vented to regulator vent lines if backloading won't occur. No vent line required if switch has no diaphragm.	4-2.4.5.5
7	Relief valve required if gas pressure at regulator inlet exceeds rating of safety shutoff valve. Physical location can be upstream to meet application requirements.	5-7.1.7
8	Two listed* safety shutoff valves required for each main and pilot gas burner system. Both safety shutoff valves must close after interruption of interlocks, combustion safeguard, or operating controls; no exceptions allowed for multiple burner systems. A single valve can be used for explosion resistant radiant tube systems.	5-7.2.1 5-7.1.2
9	Position indication (not proof-of-closure) required on safety shutoff valves to burners or pilots in excess of 150,000 Btu/hr (44 kW). Electrical indicators must not replace mechanical indicators.	5-7.1.8
10	For capacities over 400,000 Btu/hr (117 kW) both safety shutoff valves must have a closed position switch to interlock with the pre-purge.	5-7.2.2
11	Permanent and ready means for checking leak tightness of safety shutoff valves. Test in progressive intervals starting weekly, monthly, quarterly, then annually.	5-7.2.3
12	Listed* low gas pressure switch (normally open, makes on pressure rise).	5-8.1
13	Listed* high gas pressure switch (normally closed, breaks on pressure rise).	5-8.2
14	Flame Supervision: <ul style="list-style-type: none"> • Piloted burners <ul style="list-style-type: none"> - <i>Continuous pilot</i>: Two flame sensors must be used, one for the pilot flame and one for the main burner flame. - <i>Intermittant pilot</i>: Can use a single flame sensor for self-piloted burners (from same port as main, or has a common flame base and has a common flame envelope with the main flame). - <i>Interrupted pilot</i>: A single flame sensor is allowed. • Line, Pipe, Radiant burners <ul style="list-style-type: none"> - If the burners are adjacent and light safely and reliably from burner to burner, then a single sensor is allowed if it is located at the farthest end from the source of ignition. • Continuous (>24 hr) operation with UV scanners must use self checking style scanners (or use flame rods instead). 	5-9 5-9.2.1 5-9.2.2 5-9.2

Continued on next page

Item	Description	Reference Paragraph																		
15	Spark Ignition: <ul style="list-style-type: none"> • Except for explosion resistant radiant tube systems, direct spark igniters must be shut off after main burner trial-for-ignition. • If a burner must be ignited at reduced input (forced low fire start), an ignition interlock must be provided to prove control valve position. • Trial-for-ignition of the pilot or main must not exceed 10 seconds. An exception is allowed where fuel accumulation in the heating chamber can not exceed 25% of the lower explosive limit and the authority having jurisdiction approves a written request for extended time. • Manual (pushbutton) ignition systems must be designed to prevent further spark after the trial-for-ignition until a full purge is first completed. 	5-15.2 5-15.1 5-4.2.2 5-15																		
16	Listed* combustion air flow or pressure proving switch (normally open, makes on pressure rise).	5-6.4																		
17	A Listed* normally open (N.O.) vent valve with vent pipe run to a safe outside location is required when the line capacity exceeds 400,000Btu/hr (117kW). Do not manifold to other vent lines. Size the vent line according to the following table. <table border="1" data-bbox="578 600 992 894" style="margin-left: auto; margin-right: auto;"> <thead> <tr> <th>Fuel Line Size</th> <th>Vent Line Size</th> </tr> </thead> <tbody> <tr> <td>≤ 1½"</td> <td>¾"</td> </tr> <tr> <td>2"</td> <td>1"</td> </tr> <tr> <td>2½"</td> <td>1¼"</td> </tr> <tr> <td>3½"</td> <td>1½"</td> </tr> <tr> <td>4"</td> <td>2"</td> </tr> <tr> <td>5½"</td> <td>2½"</td> </tr> <tr> <td>6½"</td> <td>3"</td> </tr> <tr> <td>8"</td> <td>3½"</td> </tr> </tbody> </table> <p>As an alternate to using a vent valve, use a valve tightness proving system that is automatically activated upon startup and shutdown</p>	Fuel Line Size	Vent Line Size	≤ 1½"	¾"	2"	1"	2½"	1¼"	3½"	1½"	4"	2"	5½"	2½"	6½"	3"	8"	3½"	5-7.2.1
Fuel Line Size	Vent Line Size																			
≤ 1½"	¾"																			
2"	1"																			
2½"	1¼"																			
3½"	1½"																			
4"	2"																			
5½"	2½"																			
6½"	3"																			
8"	3½"																			

*Underwriters Laboratory (UL) listing is accepted throughout the United States. Listed products can be found in the UL Gas and Oil Equipment Directory, available from Underwriters Laboratory, Inc. Publications Stock, 333 Pfingsten Road, Northbrook, IL 60062-2096. Factory Mutual (FM) listed equipment is also acceptable in most jurisdictions and can be found in the FM Approval Guide available from Factory Mutual Research Corporation, 115 Boston-Providence Turnpike, Norwood, MA 02062.

More information can be obtained by contacting:

Industrial Risk Insurers
 85 Woodland Street
 Hartford, CT 06102-5010
 860-520-7329
 860-520-7559 fax
<http://www.industrialrisk.com>

National Fire Protection Association
 1 Batterymarch Park
 Quincy, MA 02269-9101
 800-344-3555
 508-895-8300
<http://www.nfpa.org>

Tech Notes

Heating Values of Flammable Liquids

Designers of fume incinerators are sometimes concerned about the heating value of the solvents being incinerated. The table below lists approximate heating values of various commercial solvents and flammable liquids, calculated from the references at the bottom of page 109.

Liquid	Gross Heating Value	
	Btu/U.S. Gallon	Btu/lb.
Acetone	87,360	13,040
n-Amyl Acetate	105,670	14,410
sec-Amyl Acetate	105,670	14,410
Amyl Alcohol	110,290	16,220
Benzene (<i>Benzol</i>)	132,150	18,100
n-Butyl Acetate	97,480	13,250
n-Butyl Alcohol	104,760	15,640
sec-Butyl Alcohol	104,760	15,640
Butyl Cellosolve (<i>Glycol Monobutyl Ether</i>)	105,630	14,040
Butyl Propionate	106,060	14,130
Camphor	143,010	17,150
Carbon Disulfide	61,210	5,650
Cellosolve (<i>Ethylene Glycol Monoethyl</i>)	91,960	11,790
Cellosolve Acetate (<i>Ethylene Glycol Monoethyl Ether Acetate</i>)	87,140	10,720
Chlorobenzene-mono	105,420	11,490
m- or p-Cresol	122,870	14,730
Cyclohexane	130,300	20,050
Cyclohexanone	117,900	15,710
p-Cymene	146,000	19,450
Denatured Alcohol	68,670 *	9,930 *
Dibutyl Phthalate	109,630	13,150
o-Dichlorobenzene	86,330	7,960
N-Dimethyl Formamide	85,340	11,370
p-Dioxane (<i>Diethylene Dioxide</i>)	89,380	10,720
Ethyl Acetate	82,420	10,990
Ethyl Alcohol	84,250	12,770
Ethyl Ether	93,730	16,060

(continued on page 109)

* Approximate; liquid is a mixture whose composition may vary.

Liquid	Gross Heating Value	
	Btu/U.S. Gallon	Btu/lb.
Ethyl Lactate	78,990	9,470
Ethyl Methyl Ether	86,700	14,850
Ethyl Propionate	90,970	12,290
Gasoline	129,000 *	21,050 *
Hexane	113,850	20,700
Kerosene (<i>Fuel Oil #1</i>)	131,000–137,000 *	19,700–19,900 *
Methyl Acetate	71,610	9,300
Methyl Alcohol	63,490	9,620
Methyl Carbitol (<i>Diethylene Glycol Methyl Ether</i>)	89,650	10,340
Methyl Cellosolve	81,190	10,080
Methyl Cellosolve Acetate	79,530	9,470
Methyl Ethyl Kerosene (<i>2-Butanone</i>)	97,710	14,580
Methyl Lactate	80,160	8,810
Nitrobenzene	90,170	9,010
Nitroethane	50,190	5,470
Nitromethane	17,010	1,850
1-Nitropropane	66,290	7,950
2-Nitropropane	65,760	7,950
Propyl Acetate	85,770	11,430
Propyl Alcohol	96,560	14,410
iso-Propyl Alcohol	93,160	14,120
n-Propyl Ether	109,280	17,470
Pyridine	122,210	14,920
Toluene	131,970	18,330
Turpentine	163,500 *	20,000 *
Vinyl Acetate	71,610	9,540
o-Xylene	135,870	18,610

* Approximate; liquid is a mixture whose composition may vary.

NFPA 325M-1984, *Fire Hazard Properties of Flammable Liquids, Gases, and Volatile Solids*.

Handbook of Chemistry and Physics, 40th Edition, 1959.

Tech Notes

Immersion Tube Sizing

In 1944, AGA Testing Laboratories published Research Bulletin No. 24, "Research in Fundamentals of Immersion Tube Heating With Gas". This landmark paper established beyond a doubt that the thermal efficiency of immersion tubes was strictly a function of their length—tube diameter had no effect. From their tests, AGA also developed an empirical relationship between thermal efficiency, effective tube length and burner firing rate for immersion tubes in boiling water:

$$E = 20 \log \frac{L^2}{R} + 71$$

where E = thermal efficiency, %

L = effective tube length, ft.

R = burner input rate, 1000's of Btu/hr

Effective tube length is the total centerline length of the tube immersed in water, including elbows, plus 1.1 feet for each elbow or return bend.

This equation is the basis of the tube sizing charts in Eclipse literature.

The fact that tube diameter had no effect on efficiency came as a shock to many people, but it makes sense when you think about it. Increasing the tube diameter increases the heat transfer surface, but it also produces lower gas velocity inside the tube, thus promoting a thicker gas boundary layer along the inside walls of the tube. This leads to poorer heat transfer. AGA's studies determined that the loss in convection heat transfer almost exactly offset the gain in transfer surface.

Over 40 years have passed since this paper was published. Far more sophisticated heat transfer equations have been developed, and we now have computers to perform the calculations, yet no one has been able to make a significant improvement to the speed and accuracy of AGA's equation.

The curves in the graph on page 111 were calculated from the AGA equation.

Figure 1:

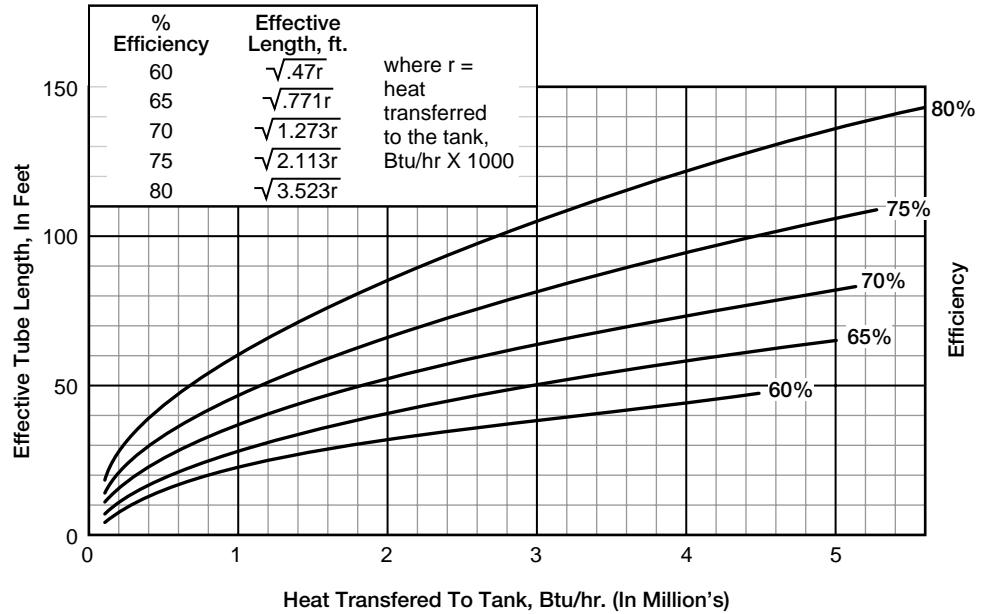

If heat transfer requirements don't determine immersion tube diameters, what does?

Burner design does—more specifically, the burner's ability to fire against the back pressure of the immersion tube.

Atmospheric burners operate at very low mixture pressures and depend on natural draft to pull secondary air into the tube. Consequently, the firing rate has to be kept low to avoid hot gases backing out of the tube around the burner head.

Sealed, forced draft burners operate at higher pressures, so they can be used to push tubes to higher firing rates. The operating pressures of the combustion system determine just how hard the tube can be fired. That's why Immerso-Jet small bore burner systems, with their high operating pressures, can operate satisfactorily at higher inputs per sq. in. of tube cross-section than packaged IP burners. Figure 2 lists approximate maximum firing rates in Btu/sq. in. of tube cross-section for various types of burner systems.

Figure 2:

Burner System Type	Max. Firing rate, Btu/Sq. In. of Tube Cross-Section
--------------------	---

Tech Notes

Submerged Combustion

Submerged combustion is the practice of heating liquids by bubbling a burner's hot combustion products through them. The process, which originated over 100 years ago, was first used to generate low pressure steam, but later became popular as a way to concentrate chemical solutions by evaporation. It is also viewed as an efficient way to heat water solutions to moderate temperatures, although its success has been somewhat spotty in this application. It agitates the bath and causes the water to become more acidic as CO_2 in the combustion products dissolves in the bath. Depending on the process, these features can be either advantages or drawbacks.

Over the years a variety of designs have evolved, but most modern units are some version of either the single-tube or manifold design.

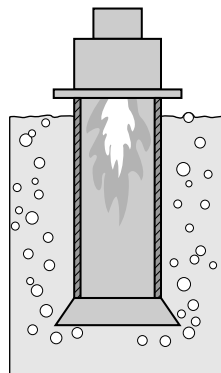

Single Tube Combustor

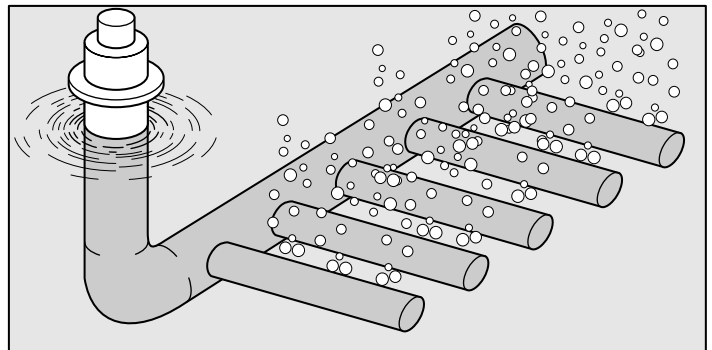

Manifold Type Combustor

Single-tube units have a relatively small coverage area, so their use is restricted to tanks with fairly confined dimensions. On the other hand, manifold-type combustors can be custom-designed to fit tanks of any reasonable dimensions without the need to locate the combustor near the center of the tank. This permits submerged combustors to be used on dip tanks and other jobs where the tank volume must be free of obstructions.

Submerged combustion gets its reputation for high efficiency from the fact that the combustion gases come into direct contact with the liquid, creating excellent heat transfer. Below about 140° F, all the water vapor in the combustion products condenses into the bath, releasing its latent heat of vaporization and producing thermal efficiencies of 90-95%, based on the higher heating value of the fuel.

Above 140° F water begins to vaporize, and the efficiency drops quickly. One unusual effect of bubbling combustion products through water is that it lowers the water's boiling point. For natural gas burned at sea level, the boiling point is about 190° F; for propane, it is about 180° F. Higher altitudes will depress the boiling point even further. If the purpose of the system is to boil water away, this is an asset, but if its purpose is only heating water, process thermal efficiency is zero at the boiling point.

From the efficiency curve below, you can see that at 165° F liquid temperature, a submerged combustion system has a thermal efficiency of 70%, equivalent to a conventional immersion tube system. At higher temperatures, it is less efficient. To compete with an 80% efficient immersion tube such as the IJ Small Bore system, a submerged combustion system would have to operate at 155° F or less.

Figure 1:

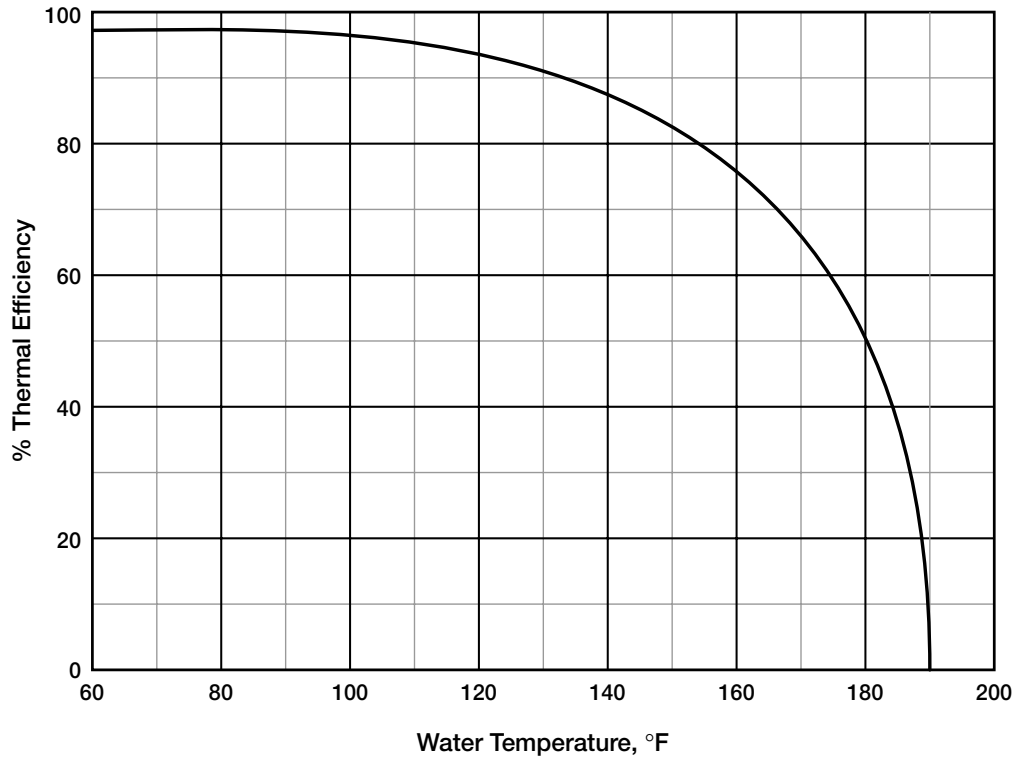

Custom-built submerged combustion units are available, although many successful jobs have been done with standard burner equipment.

The tank must be deep enough to provide at least 16-20" of bubble path through the liquid. Shallower tanks will not allow time for optimum heat transfer. Beyond 20", the improvement in heat transfer is negligible, but the tank may have to be deeper simply to accommodate the length of the combustion tube, which has to be large enough to allow completion of the flame.

All portions of the tube immersed in the tank can be bare metal. Customary practice is to locate the burner mounting flange within a few inches of the liquid level so the entire tube can be left bare. Be sure to choose an alloy that won't corrode in the solution.

Single-tube combustors are often provided with a perforated conical skirt on the bottom to aid in breaking up and distributing the flue gases. Manifold systems are subject to a lot of design variations, but a few general rules apply:

- Large tanks will require distribution pipes to carry the combustion products throughout the tank. Don't depend on a single combustor isolated in one corner to provide uniform tank heating.
- Gas distribution openings in the pipe manifolds are most commonly single rows of drilled holes, although slot openings have also been used. There aren't any universally accepted rules on hole sizing, but anything smaller than 1/4" diameter is probably a waste of effort.
- The effect of hole location (facing up, down or sideways) on heat transfer is probably negligible. However, facing the holes downward aids draining the water out of the manifold when the system is started up. Be sure to provide a couple of inches clearance between the manifolds and the tank floor (more, if you expect sludge or debris to accumulate).
- Total area of the distribution holes is, again, a matter of individual preference, but one square inch of opening for every 50-60,000 Btu/hr firing rate gives a good compromise between even distribution and low pressure drops.
- Design the manifold so it is free to expand without constraint. Otherwise, broken welds and leaks are sure to result.
- When filled with combustion gases, the distribution tube will become buoyant and try to float. Long, cantilevered tubes will vibrate and thrash around the tank. Be sure they're properly anchored to the tank bottom.

Remember that the head pressure of the liquid in the tank has to be added to all the normal air and gas supply pressures.

Nozzle mix burners are strongly preferred; the flashback tendencies of premix burners can be aggravated by fluctuations in system back pressure.

Flame length should be no more than 1/2 to 2/3 the length of the combustor tube, or the flame is apt to be quenched, forming CO and aldehydes.

High levels of humidity are normal around tanks heated with submerged combustors. Condensation will tend to collect on spark igniters, flame rods and scanner cells. Provide them with air purging if this is expected to be a problem. Use weather-resistant boots on electrode connectors, and all electrical wiring and control boxes should be selected or situated to exclude moisture. Combustion air blowers should be located where they won't draw in excessively humid air.

This will be dictated in part by safety requirements, but all systems should have a prepurge to remove the water from the combustor tube and distribution manifold. Regardless of burner capacity, low fire lightoff is strongly recommended.

Depending on the tank volume and the area over which the combustion gases are bubbled, the liquid surface will be agitated anywhere from a gentle rolling motion to a violent boil. Splashing and spilling over the sides of the tank can occur, and precaution should be taken to avoid exposing workers and equipment to hot and/or corrosive liquid.

Thermal Manual of Submerged Combustion, Thermal Research & Engineering Corp., Conshohocken, PA 1961.

“Tank & Solution Heaters for the Chemical Industry” *AGA Information letter No. 115*, N.E. Keith, A.G.A., New York, 1960.

Tech Notes

Immersion Tubes—What Will The Stack Temperature Be?

Eclipse Combustion Engineering Guide, p. 51

Customers laying out immersion tube systems frequently ask what stack temperatures they should expect. You can make a good approximation from the available heat chart below. The heat transferred through an immersion tube is the available heat in that system; everything else is flue gas loss, so it's easy to calculate flue gas temperature by working backward on the available heat chart. All you need to know is the tube efficiency and the amount of excess air at high fire.

For example, let's say you had an immersion system operating at 70% thermal efficiency and 25% excess air at high fire. Starting at 70% available heat (with available heat equal to efficiency), read across until you hit the 25% excess air curve and then drop straight down to get the flue gas exit temperature, which, in this case, is 950°F.

Figure 1:

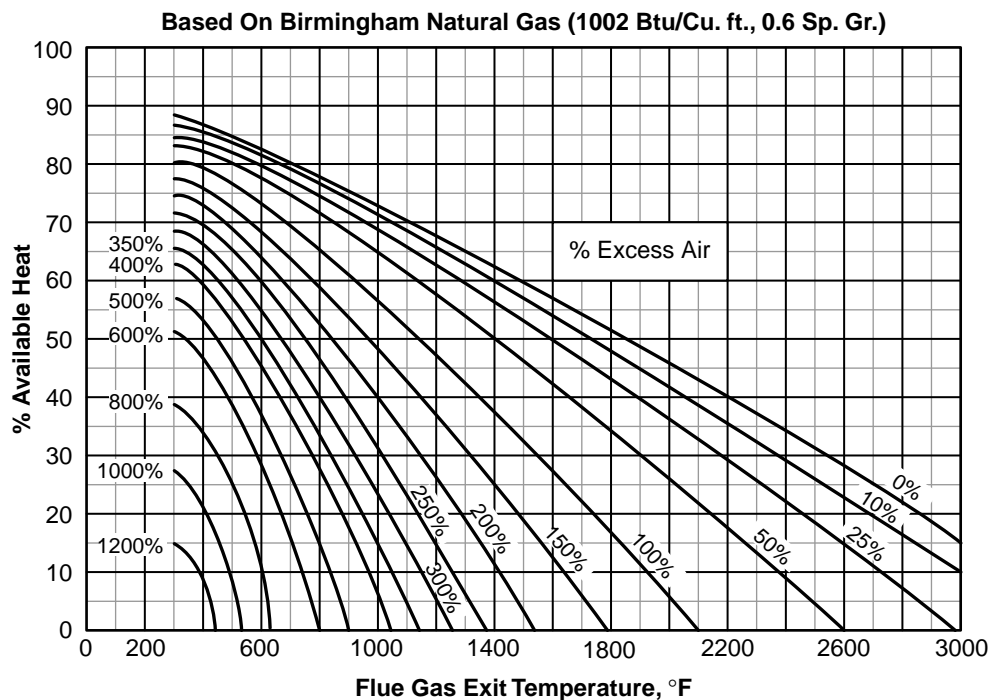

Tech Notes

Determining % O₂ in a Recirculating System

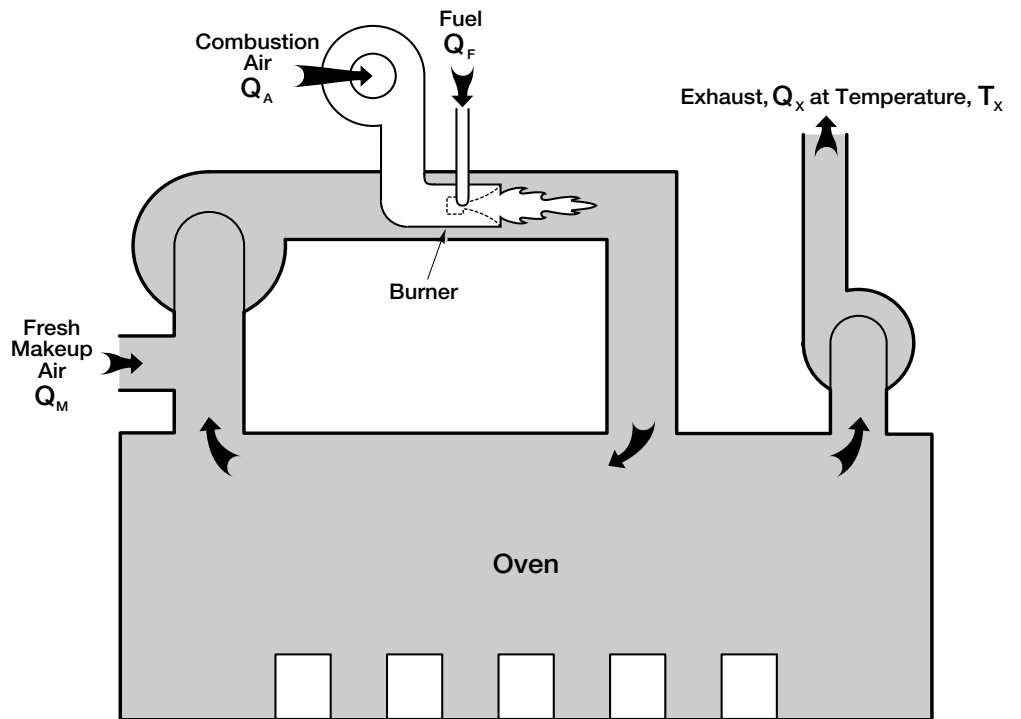

To determine O₂ content in a recirculating system, you need to know:

Q_x =oven exhaust volume, acfm

T_x =oven exhaust temperature

Q_F =maximum fuel flow to burner, scfm

R =stoichiometric air-fuel ratio (e.g., 10:1 for natural gas, 25:1 for propane, or whatever)

1. Determine scfm of exhaust.

$$Q_E \text{ in scfm} = Q_X \text{ in acfm} \times \frac{520}{T_X + 460}$$

The temperature correction factor, $\frac{520}{T_X + 460}$, equals the specific gravity of the exhaust at temperature T_X .

For simplicity's sake, assume the exhaust has properties nearly equal to air. Then you can use the specific gravity figures on page 21 of the *Eclipse Combustion Engineering Guide*.

2. For the oven to be balanced, the sum of fuel to the burner (Q_F), air to the burner (Q_A), and fresh makeup air (Q_M) must equal the exhaust volume:

$$Q_E = Q_F + Q_A + Q_M$$

3. Determine the portion of makeup and combustion air which is consumed in burning the fuel. This equals:

$$R \times Q_F$$

The remaining unconsumed fresh air determines the oxygen level in the oven. It equals:

$$Q_E - Q_F - (R \times Q_F)$$

4. Calculate oxygen content in oven, assuming 20.8% oxygen in the fresh air stream.

$$\%O_2 = 20.8 \times \left(\frac{Q_E - Q_F - (R \times Q_F)}{Q_E} \right)$$

or in its simplest form:

$$\%O_2 = 20.8 \times \left(\frac{Q_E - (1 + R) Q_F}{Q_E} \right)$$

For example, we have an oven exhausting 2000 acfm at 600° F. The burner is rated at 1.8 million Btu/hr on 1000 Btu/cu.ft. natural gas (10:1 stoichiometric ratio).

At 600° F, the specific gravity of air is .500, so $Q_E = (2000) (.500) = 1000$ scfm

Q_F , the maximum fuel input, is 1,800,000 Btu/hr divided by 1000 Btu/cu.ft. = 1800 scfh. 1800 cfh divided by 60 minutes = 30 scfm

R, the stoichiometric air-gas ratio, is given as 10:1, so:

$$\%O_2 = 20.8 \times \left(\frac{1000 - (1 + 10) 30}{1000} \right) = 20.8 \times \left(\frac{670}{1000} \right) = 13.94\%O_2$$